



Since 1957...

Kayalar Şirketler Grubu 1957 de kurulmuştur.Kuruluş tarihinden bu yana Endüstriyel Mutfak Sektöründe faaliyet göstermekte olup yarım yüzyıllık tecrübesiyle sektörün lider kuruluşlarından biri haline gelmiştir.

Bugün 26.000 m² kapalı olmak üzere 45.000 m²'lik alanda 500'den fazla personelle Endüstriyel Mutfak cihazları imalatı, mutfak ekipmanları imalatı, tasarımı, mutfak proje ve taahhüt konuları kapsayan yaklaşık 2500 çeşit ürün ile sektöründe öncü olmaya devam etmektedir.

Kuruluşumuz yurtiçi ve yurtdışı proje ortaklarımızla yaptığı uyumlu çalışmalarla gerek sektörün tanıtımı gerekse yeni ürünlerin tüketicilerin hizmetine sunulması ile yapılan ihracat ve ülkemize sağlanan döviz girdileriyle de üstlenmiş olduğu misyonu yerine getirmektedir. Türkiye genelinde 8 adet satış mağazası ve 54 adet bayiimizle hizmet vermekteyiz. Yeni katılımlar ve yatırımlarla bu hizmet ağıımızı daha da genişletmeye devam etmekteyiz.

Kalite anlayışını sadece üretim ile sınırlamayıp satış öncesi ve satış sonrası faaliyetlerimizde de yaptığımız çalışmalarla müşteri memnuniyetini esas alan ilkelerimiz doğrultusunda çalışmaktayız. Yeni teknolojilere uyumlu olarak yapılan ürünleri tüketicilere fayda sağlayacak ergonomik tasarımları, uluslar arası standartlara uygun olarak gerçekleştirmek, insan kaynaklarımıza verdiğimiz önemle müşterilerimize verdiğimiz iyi hizmetlerimize devam etmiş ve çağımızın koşulları gereği misyonumuzu en iyi şekilde devam ettirmeye kararlıyız.

Saygılarımızla,
Kayalar Şirketler Grubu

Kayalar group of companies was established in 1957. Since foundation Kayalar Group has been operating in Industrial Kitchen sector and has become one of the industry's leading organizations with its half century experience ,

Today, with 45,000 m² land including 26.000 m² closed area and more than 500 personnel, manufacturing Stainless steel industrial kitchen equipments ,designing kitchens, making projects, manufacturing about 2,500 kinds of products in the sector and continue to be leading company.

Our organization fulfill undertaken mission with coordination domestic and international project partners, introduction of industry, presenting new products to consumers, with export and provided foreign exchange inputs. We serve with 8 stores and 54 dealer across in Turkey and continuo to expand our service network with new contributions and investments.

We formed our quality principles of production and services before and after selling on the way of customers expectations . We are determined to keep up our mission by improving the products and service system on the way of customers needs and international standards.

Your Respectfully
Kayalar Group

600 SERİSİ PİŞİRİCİLER / 600 SERIES COOKERS.....	5-17
700 SERİSİ PİŞİRİCİLER / 700 SERIES COOKERS.....	19-36
900 SERİSİ PİŞİRİCİLER / 900 SERIES COOKERS.....	37-56
FIRINLAR - PİŞİRİCİLER / OVENS - COOKERS.....	57-63
FAST FOOD PİŞİRİCİLER / FAST FOOD COOKERS.....	65-73
SOĞUTUCULAR / COLD SYSTEMS.....	75-92
BULAŞIK MAKİNELERİ / DISHWASHER MACHINES.....	93-100
ÇALIŞMA TEZGAHLARI / WORK TABLES.....	101-122
BAR ÜNİTELERİ / BAR UNITS.....	123-126
AÇIK BÜFE ÜNİTELERİ / BUFFET & SERVICE UNITS.....	127-150
TAŞIMA EKİPMANLARI / CARRIAGE EQUIPMENTS.....	151-154
MUTFAK YARDIMCI EKİPMANLARI / KITCHEN AUXILIARY EQUIPMENTS.....	155-173
SERVİS EKİPMANLARI / SERVICE EQUIPMENTS.....	175-186
İTHAL ÜRÜNLER / IMPORT PRODUCTS.....	187-198
SAHRA MUTFAK / FIELD KITCHEN.....	199-205

* Firmamız; fiyat listesinde yer alan ürünlerle ilgili teknik özellikleri, ebat ve diğer tüm bilgileri haber vermeden değiştirme hakkına sahiptir.

* Fiyat Listesinde yer alan ve firmamızın kendi üretimi olan ürünlerimizin isim, kod no ve resimleri, firmamızın yazılı izni olmadan kopya edilemez ve kullanılamaz.

* Firmamız, önceden haber vermeden fiyat değiştirme hakkına sahiptir.

* Our company has the right to change technical specifications, size and all other information related to the products in the price list without prior notice

* Our own products name, code number and pictures cannot be copied and used without written consent

* Our company has the right to change the price without prior notice

Piřiriciler 600 Seri

Cookers 600 Series



www.kayalarmutfak.com.tr

444 5 957





Ocak / Cooker



Kod / Code	: 806430701
Model No	: KGO-4060
Boyut / Size (mm)	: 400 x 620 x 300
Güç / Power(Kw)	: 6,4
Tüketim / Consump. (m ³ /h - Kg/h)	: 0,676 - 0,504
Hacim/Volume(m ³)	: 0,11
Ağırlık / Weight(Kg)	: 20
Paket Ölç./Pkg Dim(mm)	: 440 x 720 x 530
Fiyat / Price €	: 500,00 €

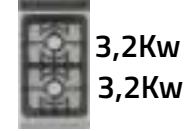

Ocak / Cooker



Kod / Code	: 806630701
Model No	: KGO-6060
Boyut / Size (mm)	: 600 x 620 x 300
Güç / Power(Kw)	: 12,8
Tüketim / Consump. (m ³ /h - Kg/h)	: 1,353 - 1,008
Hacim / Volume(m ³)	: 0,17
Ağırlık / Weight(Kg)	: 35
Paket Ölç./Pkg Dim(mm)	: 640 x 720 x 530
Fiyat / Price €	: 700,00 €



- TR** * Lpg ve Doğalgaz ile çalışır.
* Brülörler primer ve seconder yanma özelliği sayesinde yüksek yanma veriminin yanında düşük atık gaz emisyonu ile dünya standartlarında ve çevrecidir.
* Her brülör için kazayla sönmeye karşı gaz kesme kiti içeren magnet emniyet ventilli gaz muslukları bulunur.
* Tek parça basılmış üst tabla
* Cihaz altına dolap bağlantısı yapılabilir

- EN** * Works with Lpg and Natural Gas.
* Burners are world-class and environmentally friendly with low combustion gas emissions as well as high combustion efficiency thanks to primary and secondary burning capability.
* Each burner has a magnet safety valve with gas shut-off kit for accidental extinguishment.
* Deep drawn stainless top
* Cabinet connection under the device can be made



Ocak / Cooker



Kod / Code	: 806430702
Model No	: KEO-4060
Boyut / Size (mm)	: 400 x 620 x 300
Güç / Power(Kw)	: 4,0
Voltaj / Voltage	: 400 V
Hacim / Volume(m ³)	: 0,11
Ağırlık / Weight(Kg)	: 18
Paket Ölç./Pkg Dim(mm)	: 440 x 720 x 530
Fiyat / Price €	: 450,00 €



Ocak / Cooker



Kod / Code	: 806630702
Model No	: KEO-6060
Boyut / Size (mm)	: 600 x 620 x 300
Güç / Power(Kw)	: 7,5
Voltaj / Voltage	: 400 V
Hacim / Volume(m ³)	: 0,17
Ağırlık / Weight(Kg)	: 30
Paket Ölç./Pkg Dim(mm)	: 640 x 720 x 530
Fiyat / Price €	: 650,00 €



- TR** * Birbirinden bağımsız olarak ısıtıcıların her biri kademeli şalter kontrolü ile çalışmaktadır.
* Tek parça basılmış üst tabla
* Kullanıcıya her yönden rahatlık sağlayan ergonomik dizayna sahiptir.
* Sağlam konstrüksiyonu ile emniyetli kullanım sağlar.
* Cihaz altına dolap bağlantısı yapılabilir

- EN** * Each of the heaters can be operated seperately by gradedet switches.
* Deep drawn stainless top
* Ergonomical design provides comfort to the user
* Safe usage through solid construction
* Unit to be mounted on open base cupboards



Fritöz/Deep Fryer

Kod / Code	: 806430102
Model No	: KEF - 4060
Boyut / Size (mm)	: 400 x 620 x 300
Güç / Power(Kw)	: 7,0
Sıcaklık / Temperature (°c)	: 100 - 180
Voltaj / Voltage	: 400 V
Kapasite / Capacity (Lt)	: 10
Hacim / Volume(m³)	: 0,11
Ağırlık / Weight(Kg)	: 32
Paket Ölç./Pkg Dim(mm)	: 440 x 720 x 530
Fiyat / Price €	: 800,00 €



Fritöz/Deep Fryer

Kod / Code	: 806630102
Model No	: KEF - 6060
Boyut / Size (mm)	: 600 x 620 x 300
Güç / Power(Kw)	: 7+7=14
Sıcaklık / Temperature (°c)	: 100 - 180
Voltaj / Voltage	: 400 V
Kapasite / Capacity (Lt)	: 10 + 10
Hacim / Volume(m³)	: 0,17
Ağırlık / Weight(Kg)	: 42
Paket Ölç./Pkg Dim(mm)	: 640 x 720 x 530
Fiyat / Price €	: 1.250,00 €



- TR** * Isıtıcılar, temizleme ve bakım kolaylığı için kaldırılabilir şekilde ve ısıyı homojen yayacak biçimde tasarlanmıştır
* Yağ sıcaklığının maksimum 180 °C' e kadar termostatik kontrolü
* Yağın aşırı ısınması durumunda limit termostat ısıtıcıları devre dışı bırakır ve emniyetli çalışma sağlar.
* Uzun ömürlü, kolay temizlenebilir ve hijyeniktir.
* Havuzdan yağın boşaltılması için önde boşaltma vanası
* Maksimum güvenliği sağlamak için ; temizlik ve bakım esnasında ısıtıcı sistemi yukarıdayken , ısıtıcı enerjisini kesen sistem cihaza dahil edilmiştir.
* Cihaz altına dolap bağlantısı yapılabilir

- EN** * Lifiable heating system with resistances designed for homogeneous heat distribution, provides easy cleaning and maintenance.
* Thermostatic regulation of oil temperature up to a maximum of 180 °C.
* In case of over heating of the oil , limit thermostat stops the heating elements and provides safety operate.
* Long life, easy cleaning, and hygienic due to its stainless steel construction.
* Spherical valve to drain oil from the container included on the front side
* Safety system shutting off energy of the heaters included, to provide maximum safety through maintenance and cleaning while heat system lifted up
* Cabinet connection under the device can be made



Izgara Düz /Grill Smooth

Kod / Code	: 806430511
Model No	: KGDI - 4060
Boyut / Size (mm)	: 400 x 620 x 300
Tüketim / Consump. (m³/h - Kg/h)	: 0,422 - 0,315
Güç / Power(Kw)	: 4,0
Hacim / Volume(m³)	: 0,11
Ağırlık / Weight(Kg)	: 30
Paket Ölç./Pkg Dim(mm)	: 440 x 720 x 530
Fiyat / Price €	: 550,00 €



Izgara Düz /Grill Smooth

Kod / Code	: 806630511
Model No	: KGDI - 6060
Boyut / Size (mm)	: 600 x 620 x 300
Tüketim / Consump. (m³/h - Kg/h)	: 0,844 - 0,630
Güç / Power(Kw)	: 8,0
Hacim / Volume(m³)	: 0,17
Ağırlık / Weight(Kg)	: 40
Paket Ölç./Pkg Dim(mm)	: 640 x 720 x 530
Fiyat / Price €	: 770,00 €



- TR** * Lpg ve Doğalgaz ile çalışır.
* Her brülör için kazayla sönmeye karşı gaz kesme kiti ve pilot içeren magnet emniyet ventilli gaz muslukları bulunur.
* Kızartma yüzeyi önünde yağ toplama kanalı ve tahliyesi mevcuttur.
* Kızartma sırasında süzölen yağların biriktiği yağ çekmecesidir.
* Kontrol panelinde pilot alevini kontrol etmek için açıklık bulunur
* Cihaz altına dolap bağlantısı yapılabilir

- EN** * Can be operated with Lpg and Ng gas.
* Magnet ventil gas valves with flame failure device and pilot on each burner protect against gas leakage when accidental extinguishing of the flame occurs.
* Oil canal and drain hole take place on the front side of the grill surface
* Collecting drawer for the straining oil.
* An opening takes place on the control panel to check the pilot flame situation
* Cabinet connection under the device can be made



Izgara Oluklu / Grill Ribbed



Kod / Code	: 806430521
Model No	: KGOI - 4060
Boyut / Size (mm)	: 400 x 620 x 300
Tüketim / Consump. (m ³ /h - Kg/h)	: 0,422 - 0,315
Güç / Power(Kw)	: 4,0
Hacim / Volume(m ³)	: 0,11
Ağırlık / Weight(Kg)	: 30
Paket Ölç./Pkg Dim(mm)	: 440 x 720 x 530
Fiyat / Price €	: 685,00 €



- TR** * Lpg ve Doğalgaz ile çalışır.
 * Her brülör için kazayla sönmeye karşı gaz kesme kiti ve pilot içeren magnet emniyet ventilli gaz muslukları bulunur.
 * Kızartma yüzeyi önünde yağ toplama kanalı ve tahliyesi mevcuttur.
 * Kızartma sırasında süzülen yağların biriktiği yağ çekmecesi vardır.
 * Kontrol panelinde pilot alevini kontrol etmek için açıklık bulunur
 * Cihaz altına dolap bağlantısı yapılabilir

- EN** * Can be operated with Lpg and Ng gas.
 * Magnet ventil gas valves with flame failure device and pilot on each burner protect against gas leakage when accidental extinguishing of the flame occurs.
 * Oil canal and drain hole take place on the front side of the grill surface
 * Collecting drawer for the straining oil.
 * An opening takes place on the control panel to check the pilot flame situation
 * Cabinet connection under the device can be made



Izgara Oluklu / Grill Ribbed



Kod / Code	: 806630521
Model No	: KGOI - 6060
Boyut / Size (mm)	: 600 x 620 x 300
Tüketim / Consump. (m ³ /h - Kg/h)	: 0,844 - 0,630
Güç / Power(Kw)	: 8,0
Hacim / Volume(m ³)	: 0,17
Ağırlık / Weight(Kg)	: 40
Paket Ölç./Pkg Dim(mm)	: 640 x 720 x 530
Fiyat / Price €	: 930,00 €



- TR** * Lpg ve Doğalgaz ile çalışır.
 * Her brülör için kazayla sönmeye karşı gaz kesme kiti ve pilot içeren magnet emniyet ventilli gaz muslukları bulunur.
 * Kızartma yüzeyi önünde yağ toplama kanalı ve tahliyesi mevcuttur.
 * Kızartma sırasında süzülen yağların biriktiği yağ çekmecesi vardır.
 * Kontrol panelinde pilot alevini kontrol etmek için açıklık bulunur
 * Cihaz altına dolap bağlantısı yapılabilir

- EN** * Can be operated with Lpg and Ng gas.
 * Magnet ventil gas valves with flame failure device and pilot on each burner protect against gas leakage when accidental extinguishing of the flame occurs.
 * Oil canal and drain hole take place on the front side of the grill surface
 * Collecting drawer for the straining oil.
 * An opening takes place on the control panel to check the pilot flame situation
 * Cabinet connection under the device can be made



Izgara Yarı Oluklu / Grill 1/2 Ribbed



Kod / Code	: 806630531
Model No	: KGYI - 6060
Boyut / Size (mm)	: 600 x 620 x 300
Tüketim / Consump. (m ³ /h - Kg/h)	: 0,844 - 0,630
Güç / Power(Kw)	: 8,0
Hacim / Volume(m ³)	: 0,17
Ağırlık / Weight(Kg)	: 40
Paket Ölç./Pkg Dim(mm)	: 640 x 720 x 530
Fiyat / Price €	: 840,00 €



- TR** * Lpg ve Doğalgaz ile çalışır.
 * Her brülör için kazayla sönmeye karşı gaz kesme kiti ve pilot içeren magnet emniyet ventilli gaz muslukları bulunur.
 * Kızartma yüzeyi önünde yağ toplama kanalı ve tahliyesi mevcuttur.
 * Kızartma sırasında süzülen yağların biriktiği yağ çekmecesi vardır.
 * Kontrol panelinde pilot alevini kontrol etmek için açıklık bulunur
 * Cihaz altına dolap bağlantısı yapılabilir

- EN** * Can be operated with Lpg and Ng gas.
 * Magnet ventil gas valves with flame failure device and pilot on each burner protect against gas leakage when accidental extinguishing of the flame occurs.
 * Oil canal and drain hole take place on the front side of the grill surface
 * Collecting drawer for the straining oil.
 * An opening takes place on the control panel to check the pilot flame situation
 * Cabinet connection under the device can be made



Izgara Yarı Oluklu / Grill 1/2 Ribbed



Kod / Code	: 806630532
Model No	: KEYI - 6060
Boyut / Size (mm)	: 600 x 620 x 300
Güç / Power(Kw)	: 4,8
Sıcaklık / Temperature (°c)	: 50 - 300
Hacim / Volume(m ³)	: 0,17
Voltaj / Voltage	: 400 V
Ağırlık / Weight(Kg)	: 40
Paket Ölç./Pkg Dim(mm)	: 640 x 720 x 530
Fiyat / Price €	: 840,00 €



- TR** * Kızartma yüzeyi önünde yağ toplama kanalı ve tahliyesi
 * Kızartma sırasında süzülen yağların biriktiği yağ çekmecesi mevcuttur.
 * 50-300 °C arası termostatik sıcaklık kontrolü.
 * Uzun ömürlü, kolay temizlenebilir ve hijyeniktir.
 * Cihaz altına dolap bağlantısı yapılabilir

- EN** * Oil canal and drain hole take place on the front side of the grill surface
 * Collecting drawer for the straining oil.
 * Thermostatic regulation of temperature between 50-300 °C.
 * Long life, easy cleaning, and hygienic due to its stainless steel construction.
 * Unit to be mounted on open base cupboards



Izgara Düz / Grill Smooth

Kod / Code	: 806430512
Model No	: KEDI - 4060
Boyut / Size (mm)	: 400 x 620 x 300
Güç / Power(Kw)	: 3,6
Sıcaklık / Temperature (°c)	: 50 - 300
Hacim / Volume(m³)	: 0,11
Voltaj / Voltage	: 400 V
Ağırlık / Weight(Kg)	: 30
Paket Ölç./Pkg Dim(mm)	: 440 x 720 x 530
Fiyat / Price €	: 550,00 €



Izgara Düz / Grill Smooth

Kod / Code	: 806630512
Model No	: KEDI - 6060
Boyut / Size (mm)	: 600 x 620 x 300
Güç / Power(Kw)	: 4,8
Sıcaklık / Temperature (°c)	: 50 - 300
Hacim / Volume(m³)	: 0,17
Voltaj / Voltage	: 400 V
Ağırlık / Weight(Kg)	: 40
Paket Ölç./Pkg Dim(mm)	: 640 x 720 x 530
Fiyat / Price €	: 770,00 €



- TR** * Kızartma yüzeyi önünde yağ toplama kanalı ve tahliyesi
* Kızartma sırasında süzölen yağların biriktiği yağ çekmecesi mevcuttur.
*50-300 °C arası termostatik sıcaklık kontrolü.
*Uzun ömürlü, kolay temizlenebilir ve hijyeniktir.
*Cihaz altına dolap bağlantısı yapılabilir

- EN** * Oil canal and drain hole take place on the front side of the grill surface
* Collecting drawer for the straining oil.
* Thermostatic regulation of temperature between 50-300 °C.
* Long life, easy cleaning, and hygienic due to its stainless steel construction.
* Unit to be mounted on open base cupboards



Izgara Oluklu / Grill Ribbed

Kod / Code	: 806430522
Model No	: KE0I - 4060
Boyut / Size (mm)	: 400 x 620 x 300
Güç / Power(Kw)	: 3,6
Sıcaklık / Temperature (°c)	: 50 - 300
Hacim / Volume(m³)	: 0,11
Voltaj / Voltage	: 400 V
Ağırlık / Weight(Kg)	: 30
Paket Ölç./Pkg Dim(mm)	: 440 x 720 x 530
Fiyat / Price €	: 680,00 €



Izgara Oluklu / Grill Ribbed

Kod / Code	: 806630522
Model No	: KE0I - 6060
Boyut / Size (mm)	: 600 x 620 x 300
Güç / Power(Kw)	: 4,8
Sıcaklık / Temperature (°c)	: 50 - 300
Hacim / Volume(m³)	: 0,17
Voltaj / Voltage	: 400 V
Ağırlık / Weight(Kg)	: 40
Paket Ölç./Pkg Dim(mm)	: 640 x 720 x 530
Fiyat / Price €	: 930,00 €



- TR** * Kızartma yüzeyi önünde yağ toplama kanalı ve tahliyesi
* Kızartma sırasında süzölen yağların biriktiği yağ çekmecesi mevcuttur.
*50-300 °C arası termostatik sıcaklık kontrolü.
*Uzun ömürlü, kolay temizlenebilir ve hijyeniktir.
*Cihaz altına dolap bağlantısı yapılabilir

- EN** * Oil canal and drain hole take place on the front side of the grill surface
* Collecting drawer for the straining oil.
* Thermostatic regulation of temperature between 50-300 °C.
* Long life, easy cleaning, and hygienic due to its stainless steel construction.
* Unit to be mounted on open base cupboards



Izgara Lavatařlı / Lavastone Grill

Kod / Code	: 806430601
Model No	: KGLI - 4060
Boyut / Size (mm)	: 400 x 620 x 300
Güç / Power(Kw)	: 4,0
Tüketim / Consump. (m ³ /h - Kg/h)	: 0,422 - 0,315
Hacim / Volume(m ³)	: 0,11
Ağırlık / Weight(Kg)	: 35
Paket Ölç./Pkg Dim(mm)	: 440 x 720 x 530
Fiyat / Price €	: 550,00 €



- TR** * Lpg ve Doğalgaz ile çalışır.
* Her brülör için kazayla sönmeye karşı gaz kesme kiti ve pilot içeren magnet emniyet ventilli gaz muslukları bulunur.
* Kızartma yüzeyi önünde yağ toplama kanalı ve tahliyesi mevcuttur.
* Kızartma sırasında süzölen yağların biriktiđi yağ çekmecesi vardır.
* Kontrol panelinde pilot alevini kontrol etmek için açıklık bulunur
* Cihaz altına dolap bağlantısı yapılabilir

- EN** * Can be operated with Lpg and Ng gas.
* Magnet ventil gas valves with flame failure device and pilot on each burner protect against gas leakage when accidental extinguishing of the flame occurs.
* Oil canal and drain hole take place on the front side of the grill surface
* Collecting drawer for the straining oil.
* An opening takes place on the control panel to check the pilot flame situation
* Unit to be mounted on open base cupboards



Izgara Lavatařlı / Lavastone Grill

Kod / Code	: 806630601
Model No	: KGLI - 6060
Boyut / Size (mm)	: 600 x 620 x 300
Güç / Power(Kw)	: 8,00
Tüketim / Consump. (m ³ /h - Kg/h)	: 0,845 - 0,630
Hacim / Volume(m ³)	: 0,17
Ağırlık / Weight(Kg)	: 50
Paket Ölç./Pkg Dim(mm)	: 640 x 720 x 530
Fiyat / Price €	: 800,00 €



- TR** * Lpg ve Doğalgaz ile çalışır.
* Her brülör için kazayla sönmeye karşı gaz kesme kiti ve pilot içeren magnet emniyet ventilli gaz muslukları bulunur.
* Kızartma yüzeyi önünde yağ toplama kanalı ve tahliyesi mevcuttur.
* Kızartma sırasında süzölen yağların biriktiđi yağ çekmecesi vardır.
* Kontrol panelinde pilot alevini kontrol etmek için açıklık bulunur
* Cihaz altına dolap bağlantısı yapılabilir

- EN** * Can be operated with Lpg and Ng gas.
* Magnet ventil gas valves with flame failure device and pilot on each burner protect against gas leakage when accidental extinguishing of the flame occurs.
* Oil canal and drain hole take place on the front side of the grill surface
* Collecting drawer for the straining oil.
* An opening takes place on the control panel to check the pilot flame situation
* Unit to be mounted on open base cupboards



Makarna Hařlama / Pasta Cooker

Kod / Code	: 806430202
Model No	: KEM - 4060
Boyut / Size (mm)	: 400 x 620 x 300
Güç / Power(Kw)	: 4,5
Sıcaklık / Temperature (°c)	: 30 - 120
Hacim / Volume(m ³)	: 0,11
Voltaj / Voltage	: 400 V
Ağırlık / Weight(Kg)	: 28
Paket Ölç./Pkg Dim(mm)	: 440 x 720 x 530
Fiyat / Price €	: 820,00 €



- TR** * Isıtılan suyun sıcaklıđı termostatik kumanda ile 30 -120 °C arası kontrol edilebilmektedir.
* Havuzdan yağın boşaltılması için önde boşaltma vanası
* Paslanmaz çelikten imal edilmiş sepetleri sayesinde pratik piřirme sağlar.
* Cihaz altına dolap bağlantısı yapılabilir

- EN** * The temperature of water is controlled thermostatically between 30-120 °C
* Spherical valve to drain water from the container included on the front side
* Easy cooking through the stainless steel baskets.
Durable, easy to clean and hygienic due to its stainless steel construction.
* Unit to be mounted on open base cupboards



Patates Dinlendirme / Chips Scuttle

Kod / Code	: 806430402
Model No	: KEP - 4060
Boyut / Size (mm)	: 400 x 620 x 300
Güç / Power(Kw)	: 1,0
Hacim / Volume(m ³)	: 0,11
Voltaj / Voltage	: 230 V
Ağırlık / Weight(Kg)	: 25
Paket Ölç./Pkg Dim(mm)	: 440 x 720 x 530
Fiyat / Price €	: 550,00 €



- TR** * GN 2/3 x 150 mm kap kapasiteli.
* Ürün arkasında yer alan infrared seramik ısıtıcı, servis edilmeden önce servis edilecek gıdanın sıcak kalmasını sağlar
* Kullanıcıya her yönden rahatlık sağlayan ergonomik dizayna sahip.
* Süzgeç sacı vasıtasıyla patateslerin yağını süzme
* Cihaz altına dolap bağlantısı yapılabilir

- EN** * 2/3 GNx 150 mm container Capacity.
* Unit to have infrared heating elements positioned on the back of the unit to keep servings warm until ready to be plated and served.
* Ergonomical design provides comfort for the user.
* Through perforated sheet metal part, easy draining potatoes
* Unit to be mounted on open base cupboards



Bain Marie / Bain-Marie

Kod / Code : 806430302
Model No : KESB - 4060
Boyut / Size (mm) : 400 x 620 x 300
Güç / Power(Kw) : 1,5
Hacim / Volume(m³) : 0,11
Sıcaklık / Temperature (°c) : 30 - 120
Voltař / Voltage : 230 V
Ağırlık / Weight(Kg) : 20
Paket Ölç./Pkg Dim(mm) : 440 x 720 x 530
Fiyat / Price € : 500,00 €



Nötr Ara Tezgah / Neutral Worktop Unit

Kod / Code : 806430000
Model No : KAT - 4060
Boyut / Size (mm) : 400 x 620 x 300
Hacim / Volume(m³) : 0,11
Ağırlık / Weight(Kg) : 12
Paket Ölç./Pkg Dim(mm) : 440 x 720 x 530
Fiyat / Price € : 185,00 €



Nötr Ara Tezgah / Neutral Worktop Unit

Kod / Code : 806630000
Model No : KAT - 6060
Boyut / Size (mm) : 600 x 620 x 300
Hacim / Volume(m³) : 0,17
Ağırlık / Weight(Kg) : 17
Paket Ölç./Pkg Dim(mm) : 640 x 720 x 530
Fiyat / Price € : 230,00 €



Setaltı Tezgah / Under Counter Table

Kod / Code : 806450000
Model No : KAD - 4060
Boyut / Size (mm) : 400 x 620 x 580
Paket Ölç./Pkg Dim(mm) : 440 x 720 x 590
Fiyat / Price € : 170,00 €



Setaltı Tezgah / Under Counter Table

Kod / Code : 806650000
Model No : KAD - 6060
Boyut / Size (mm) : 600 x 620 x 580
Paket Ölç./Pkg Dim(mm) : 640 x 720 x 590
Fiyat / Price € : 280,00 €



**Cihaz Dolap Kapısı
Door for Cooking Series**

Kod / Code : P1001000001
Fiyat / Price € : 60,00 €

Not

Piřiriciler 700 Seri

Cookers 700 Series



www.kayalarmutfak.com.tr

444 5 957





Ocak / Cooker



Kod / Code	: 807480701
Model No	: KGOD-4070
Boyut / Size (mm)	: 400 x 740 x 850
Güç / Power(Kw)	: 12,0
Tüketim / Consump. (m ³ /h - Kg/h)	: 1,268 - 0,945
Hacim / Volume(m ³)	: 0,26
Ağırlık / Weight(Kg)	: 55
Paket Ölç./Pkg Dim(mm)	: 500 x 850 x 1100
Fiyat / Price €	: 1.000,00 €

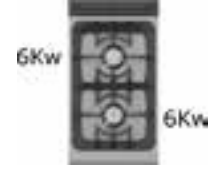

Ocak / Cooker



Kod / Code	: 807880701
Model No	: KGOD-8070
Boyut / Size (mm)	: 800 x 740 x 850
Güç / Power(Kw)	: 24,0
Tüketim / Consump. (m ³ /h - Kg/h)	: 2,536 - 1,891
Voltaj / Voltage	: 400 V
Hacim / Volume(m ³)	: 0,55
Ağırlık / Weight(Kg)	: 80
Paket Ölç./Pkg Dim(mm)	: 900 x 850 x 1100
Fiyat / Price €	: 1.300,00 €

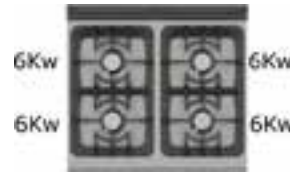

- TR** * Lpg ve Doğalgaz ile çalışır.
* Brülörler primer ve seconder yanma özelliği sayesinde yüksek yanma veriminin yanında düşük atık gaz emisyonu ile dünya standartlarında ve çevrecidir.
* Her brülör için kazayla sönmeye karşı gaz kesme kiti içeren magnet emniyet ventilli gaz muslukları bulunur.
* Değişik ölçülerde tencere kullanımına olanak sağlayacak şekilde tasarlanmış , ağır hizmet tipi ocak dökümleri teflon kaplıdır
* Tek parça basılmış üst tabla

- EN** * Works with Lpg and Natural Gas.
* Burners are world-class and environmentally friendly with low combustion gas emissions as well as high combustion efficiency thanks to primary and secondary burning capability.
* Each burner has a magnet safety valve with gas shut-off kit for accidental extinguishment.
* Heavy-duty furnace castings designed to allow the use of pots in different sizes are covered with teflon
* Deep drawn stainless top



Ocak / Cooker



Kod / Code	: 807480702
Model No	: KEOD-4070
Boyut / Size (mm)	: 400 x 740 x 850
Güç / Power(Kw)	: 4,6
Voltaj / Voltage	: 400 V
Sıcaklık / Temperature (°c)	: 50-300
Hacim / Volume(m ³)	: 0,26
Ağırlık / Weight(Kg)	: 45
Paket Ölç./Pkg Dim(mm)	: 500 x 850 x 1100
Fiyat / Price €	: 820,00 €



Ocak / Cooker



Kod / Code	: 807880702
Model No	: KEOD-8070
Boyut / Size (mm)	: 800 x 740 x 850
Güç / Power(Kw)	: 9,2
Voltaj / Voltage	: 400 V
Sıcaklık / Temperature (°c)	: 50-300
Hacim / Volume(m ³)	: 0,55
Ağırlık / Weight(Kg)	: 65
Paket Ölç./Pkg Dim(mm)	: 900 x 850 x 1100
Fiyat / Price €	: 1.100,00 €



- TR** * Birbirinden bağımsız olarak ısıtıcıların her biri kademeli şalter kontrolü ile çalışmaktadır.
* Tek parça basılmış üst tabla
* Kullanıcıya her yönden rahatlık sağlayan ergonomik dizayna sahiptir.
* Sağlam konstrüksiyonu ile emniyetli kullanım sağlar.

- EN** * Each of the heaters can be operated seperately by gradeted switches.
* Deep drawn stainless top
* Ergonomical design provides comfort to the user
* Safe usage through solid construction



Kuzine Fırınlı / Range with Oven



Kod / Code	: 807880801
Model No	: KGKF - 8070
Boyut / Size (mm)	: 800 x 740 x 850
Tüketim / Consump. (m ³ /h - Kg/h)	: 3,171 - 2,364
Güç / Power(Kw)	: 32,00
Hacim / Volume(m ³)	: 0,55
Ağırlık / Weight(Kg)	: 120
Paket Ölç./Pkg Dim(mm)	: 900 x 850 x 1100
Fiyat / Price €	: 2.000,00 €



TR

- * Lpg ve Doğalgaz ile çalışır.
- * Brülörler primer ve seconder yanma özelliği sayesinde yüksek yanma veriminin yanında düşük atık gaz emisyonu ile dünya standartlarında ve çevrecidir.
- * Her brülör için kazayla sönmeye karşı gaz kesme kiti ve pilot içeren magnet emniyet ventilli gaz muslukları bulunur.
- * Değişik ölçülerde tencere kullanımına olanak sağlayacak şekilde tasarlanmış , ağır hizmet tipi ocak dökümleri teflon kaplıdır
- * Tek parça basılmış üst tabla
- * Derin çekme ocak tepsileri üst tabladan bağımsız olup , temizliğe en hızlı ve kolay çözümü getirirken, hijyenik bir pişirme alanı sağlar
- * Fırın kapısı menteşe sistemi tek kollu olup maksimum güvenlik sağlamasının yanında iki kademeli menteşe sistemi kapı seviyelendirmesi imkanı sayesinde kullanım kolaylığı sağlar
- * Yekpare fırın gövdesi paslanmaz çelikten üretilmiştir ve fırın iç sıcaklığı magnet ventilli gaz valfi tarafından maksimum 300 °C sıcaklığa kadar 8 ayrı kademede kontrol edilebilir.
- * Fırın kısmı GN 1/1 tepsi kapasiteli ve farklı konumlarda tepsi yerleştirme özelliğine sahiptir.

EN

- * Can be operated with Lpg and Ng gas.
- * The gas burners provides a high burning fertility through primary and secondary burning and is proper to the world standart
- * Magnet ventil gas valves with flame failure device and pilot on each burner protect against gas leakage when accidental extinguishing of the flame occurs.
- * Teflon coated ,hard pan support in cast iron specially designed to provide usage of different sized pans.
- * Deep drawn stainless top
- * Deep drawn cooking departments bring fastest and ease of cleaning, assuring hygenic cooking area
- * Two leveled oven hinge system with single arm brings maximum safety in usage plus leveling the door brings ease of usage.
- * Monoblock oven body made of stainless steel and internal oven temperature controlled by thermostatic magnet ventil gas valve with eight levels maximum 300 °C



Kuzine Fırınlı/Range with oven



Kod / Code	: 807880802
Model No	: KEKF - 8070
Boyut / Size (mm)	: 800 x 740 x 850
Güç / Power(Kw)	: 14
Sıcaklık / Temperature (°c)	: 50 - 300
Voltaj / Voltage	: 400 V
Hacim / Volume(m ³)	: 0,55
Ağırlık / Weight(Kg)	: 101
Paket Ölç./Pkg Dim(mm)	: 900 x 850 x 1100
Fiyat / Price €	: 1.860,00 €



TR

- * Birbirinden bağımsız olarak ısıtıcıların her biri kademeli şalter kontrolü ile çalışmaktadır.
- * Tek parça basılmış AISI 304 kalite paslanmaz çelik üst tabla
- * Kullanıcıya her yönden rahatlık sağlayan ergonomik dizayna sahiptir.
- * Sağlam konstrüksiyonu ile emniyetli kullanım sağlar.
- * Fırın kapısı menteşe sistemi tek kollu olup maksimum güvenlik sağlamasının yanında iki kademeli menteşe sistemi kapı seviyelendirmesi imkanı sayesinde kullanım kolaylığı sağlar
- * Yekpare fırın gövdesi paslanmaz çelikten üretilmiştir ve fırın iç sıcaklığı termostatik olarak 50 - 300 °C arası kontrol edilebilir.
- * Fırın kısmı GN 1/1 tepsi kapasiteli ve farklı konumlarda tepsi yerleştirme özelliğine sahiptir.

EN

- * Each of to heaters can be operated separately by graded switches.
- * Deep drawn stainless top
- * Ergonomical design provides comfort to the user.
- * Strong body construction brings safety usage.
- * Two leveled oven hinge system with single arm brings maximum safety in usage plus leveling the door brings ease of usage.
- * Monoblock oven body made of stainless steel and internal oven temperature controlled by thermostatically between 50 - 300 °C
- * Oven has GN 1/1 Capacity and accomodate different levels.



Fritöz/Deep Fryer

Kod / Code	: 807480102
Model No	: KEFD - 4070
Boyut / Size (mm)	: 400 x 740 x 850
Güç / Power(Kw)	: 10,5
Sıcaklık / Temperature (°c)	: 100 - 180
Voltaj / Voltage	: 400 V
Kapasite / Capacity (Lt)	: 18
Hacim / Volume(m³)	: 0,26
Ağırlık / Weight(Kg)	: 48
Paket Ölç./Pkg Dim(mm)	: 500 x 850 x 1100
Fiyat / Price €	: 1.160,00 €



Fritöz/Deep Fryer

Kod / Code	: 807880102
Model No	: KEFD - 8070
Boyut / Size (mm)	: 800 x 740 x 850
Güç / Power(Kw)	: 10,5 + 10,5 = 21
Sıcaklık / Temperature (°c)	: 100 - 180
Voltaj / Voltage	: 400 V
Kapasite / Capacity (Lt)	: 18 + 18
Hacim / Volume(m³)	: 0,55
Ağırlık / Weight(Kg)	: 77
Paket Ölç./Pkg Dim(mm)	: 900 x 850 x 1100
Fiyat / Price €	: 1.950,00 €



- TR** * Isıtıcılar, temizleme ve bakım kolaylığı için kaldırılabilir şekilde ve ısıyı homojen yayacak biçimde tasarlanmıştır
* Yağ sıcaklığının maksimum 180 °C' e kadar termostatik kontrolü
* Yağın aşırı ısınması durumunda limit termostat ısıtıcıları devre dışı bırakır ve emniyetli çalışma sağlar.
* Uzun ömürlü, kolay temizlenebilir ve hijyeniktir.
* Havuzdan yağın boşaltılması için önde 3/4" küresel vana
* Maksimum güvenliği sağlamak için ; temizlik ve bakım esnasında ısıtıcı sistemi yukarıdayken , ısıtıcı enerjisini kesen sistem cihaza dahil edilmiştir.
* Cihaz altına dolap bağlantısı yapılabilir

- EN** * Lifiable heating system with resistances designed for homogeneous heat distribution, provides easy cleaning and maintenance.
* Thermostatic regulation of oil temperature up to a maximum of 180 °C.
* In case of over heating of the oil , limit thermostat stops the heating elements and provides safety operate.
* Long life, easy cleaning, and hygienic due to its stainless steel construction.
* Spherical valve to drain oil from the container included on the front side
* Safety system shutting off energy of the heaters included, to provide maximum safety through maintenance and cleaning while heat system lifted up



Fritöz/Deep Fryer

Kod / Code	: 807480101
Model No	: KGFD - 4070
Boyut / Size (mm)	: 400 x 740 x 850
Güç / Power(Kw)	: 15
Sıcaklık / Temperature (°c)	: 100 - 180
Güç / Power (Kcal)	: 25800
Kapasite / Capacity (Lt)	: 18
Hacim / Volume(m³)	: 0,26
Ağırlık / Weight(Kg)	: 48
Paket Ölç./Pkg Dim(mm)	: 500 x 850 x 1100
Fiyat / Price €	: 1.350,00 €



Fritöz/Deep Fryer

Kod / Code	: 807880101
Model No	: KGFD - 8070
Boyut / Size (mm)	: 800 x 740 x 850
Güç / Power(Kw)	: 15+15 = 30
Sıcaklık / Temperature (°c)	: 100 - 180
Güç / Power (Kcal)	: 25800
Kapasite / Capacity (Lt)	: 18 + 18
Hacim / Volume(m³)	: 0,55
Ağırlık / Weight(Kg)	: 77
Paket Ölç./Pkg Dim(mm)	: 900 x 850 x 1100
Fiyat / Price €	: 2.250,00 €



- TR** * Lpg ve Doğalgaz ile çalışır.ısıtıcılar, temizleme ve bakım kolaylığı için kaldırılabilir şekilde ve ısıyı homojen yayacak biçimde tasarlanmıştır
* Yağ sıcaklığının maksimum 180 °C' e kadar termostatik kontrolü
* Yağın aşırı ısınması durumunda limit termostat ısıtıcıları devre dışı bırakır ve emniyetli çalışma sağlar.
* Uzun ömürlü, kolay temizlenebilir ve hijyeniktir.
* Havuzdan yağın boşaltılması için 3/4" küresel vana
* Maksimum güvenliği sağlamak için ; temizlik ve bakım esnasında ısıtıcı sistemi yukarıdayken , ısıtıcı enerjisini kesen sistem cihaza dahil edilmiştir.
* Dolapların kapı yönü değişebilir

- EN** * Can be operated with LPG and NG Gas
* Lifiable heating system with resistances designed for homogeneous heat distribution, provides easy cleaning and maintenance
* Thermostatic regulation of oil temperature up to a maximum of 180 °C
* In case of over heating of the oil, limit thermostat stops the heating elements and provides safety operate.
* Long life, easy cleaning and hygienic due to its stainless steel construction.
* Spherical valve to drain oil from the container included on the front side
* Safety system shutting off energy of the heaters included, to provide maximum safety through maintenance and cleaning while heat system lifted up



Izgara Düz / Grill Smooth



Kod / Code	: 807480511
Model No	: KGDID - 4070
Boyut / Size (mm)	: 400 x 740 x 850
Güç / Power(Kw)	: 6,0
Tüketim / Consump. (m ³ /h - Kg/h)	: 0,634 - 0,472
Hacim / Volume(m ³)	: 0,26
Ağırlık / Weight(Kg)	: 60
Paket Ölç./Pkg Dim(mm)	: 500 x 850 x 1100
Fiyat / Price €	: 850,00 €



Izgara Düz / Grill Smooth



Kod / Code	: 807880511
Model No	: KGDID - 8070
Boyut / Size (mm)	: 800 x 740 x 850
Güç / Power(Kw)	: 12,0
Tüketim / Consump. (m ³ /h - Kg/h)	: 1,268 - 0,945
Hacim / Volume(m ³)	: 0,55
Ağırlık / Weight(Kg)	: 100
Paket Ölç./Pkg Dim(mm)	: 900 x 850 x 1100
Fiyat / Price €	: 1.370,00 €



TR * Lpg ve Doğalgaz ile çalışır.

* Her brülör için kazayla sönmeye karşı gaz kesme kiti ve pilot içeren magnet emniyet ventilli gaz muslukları bulunur.

* Kızartma yüzeyi önünde yağ toplama kanalı ve tahliyesi mevcuttur.

* Kızartma sırasında süzölen yağların biriktiği yağ çekmecesi vardır.

* Kontrol panelinde pilot alevini kontrol etmek için açıklık bulunur

* Cihaz altına dolap bağlantısı yapılabilir

EN * Can be operated with Lpg and Ng gas.

* Magnet ventil gas valves with flame failure device and pilot on each burner protect against gas leakage when accidental extinguishing of the flame occurs.

* Oil canal and drain hole take place on the front side of the grill surface

* Collecting drawer for the straining oil.

* An opening takes place on the control panel to check the pilot flame situation

* Unit to be mounted on open base cupboards



Izgara Oluklu / Grill Ribbed



Kod / Code	: 807480521
Model No	: KGOID - 4070
Boyut / Size (mm)	: 400 x 740 x 850
Güç / Power(Kw)	: 6,0
Tüketim / Consump. (m ³ /h - Kg/h)	: 0,634 - 0,472
Hacim / Volume(m ³)	: 0,26
Ağırlık / Weight(Kg)	: 60
Paket Ölç./Pkg Dim(mm)	: 500 x 850 x 1100
Fiyat / Price €	: 960,00 €



Izgara Oluklu / Grill Ribbed



Kod / Code	: 807880521
Model No	: KGOID - 8070
Boyut / Size (mm)	: 800 x 740 x 850
Güç / Power(Kw)	: 12
Tüketim / Consump. (m ³ /h - Kg/h)	: 1,268 - 0,945
Hacim / Volume(m ³)	: 0,55
Ağırlık / Weight(Kg)	: 100
Paket Ölç./Pkg Dim(mm)	: 900 x 850 x 1100
Fiyat / Price €	: 1.500,00 €



TR * Lpg ve Doğalgaz ile çalışır.

* Her brülör için kazayla sönmeye karşı gaz kesme kiti ve pilot içeren magnet emniyet ventilli gaz muslukları bulunur.

* Kızartma yüzeyi önünde yağ toplama kanalı ve tahliyesi mevcuttur.

* Kızartma sırasında süzölen yağların biriktiği yağ çekmecesi vardır.

* Kontrol panelinde pilot alevini kontrol etmek için açıklık bulunur

* Cihaz altına dolap bağlantısı yapılabilir

EN * Can be operated with Lpg and Ng gas.

* Magnet ventil gas valves with flame failure device and pilot on each burner protect against gas leakage when accidental extinguishing of the flame occurs.

* Oil canal and drain hole take place on the front side of the grill surface

* Collecting drawer for the straining oil.

* An opening takes place on the control panel to check the pilot flame situation

* Unit to be mounted on open base cupboards



Izgara 1/2 Oluklu / 1/2 Grill Ribbed



Kod / Code	: 807880531
Model No	: KGYID - 8070
Boyut / Size (mm)	: 800 x 740 x 850
Güç / Power(Kw)	: 12,00
Tüketim / Consump. (m ³ /h - Kg/h)	: 1,268 - 0,945
Hacim / Volume(m ³)	: 0,55
Ağırlık / Weight(Kg)	: 100
Paket Ölç./Pkg Dim(mm)	: 900 x 850 x 1100
Fiyat / Price €	: 1.440,00 €



Izgara 1/2 Oluklu / 1/2 Grill Ribbed



Kod / Code	: 807880532
Model No	: KEYID - 8070
Boyut / Size (mm)	: 800 x 740 x 850
Güç / Power(Kw)	: 7,2
Tüketim / Consump. (m ³ /h - Kg/h)	: 1,268 - 0,945
Sıcaklık / Temperature (°c)	: 50 - 300
Hacim / Volume(m ³)	: 0,55
Ağırlık / Weight(Kg)	: 95
Paket Ölç./Pkg Dim(mm)	: 900 x 850 x 1100
Fiyat / Price €	: 1.440,00 €



- TR** * Kızartma yüzeyi önünde yağ toplama kanalı ve tahliyesi
 * Kızartma sırasında süzülen yağların biriktiği yağ çekmecesi mevcuttur.
 * 50-300 °C arası termostatik sıcaklık kontrolü.
 * Uzun ömürlü, kolay temizlenebilir ve hijyeniktir.
 * Cihaz altına dolap bağlantısı yapılabilir

- EN** * Oil canal and drain hole take place on the front side of the grill surface
 * Collecting drawer for the straining oil.
 * Thermostatic regulation of temperature between 50-300 °C.
 * Long life, easy cleaning, and hygienic due to its stainless steel construction.
 * Unit to be mounted on open base cupboards



Izgara Düz / Grill Smooth



Kod / Code	: 807480512
Model No	: KEDID - 4070
Boyut / Size (mm)	: 400 x 740 x 850
Güç / Power(Kw)	: 3,6
Sıcaklık / Temperature (°c)	: 50 - 300
Voltaj / Voltage	: 400 V
Hacim / Volume(m ³)	: 0,26
Ağırlık / Weight(Kg)	: 55
Paket Ölç./Pkg Dim(mm)	: 500 x 850 x 1100
Fiyat / Price €	: 850,00 €



Izgara Düz / Grill Smooth



Kod / Code	: 807880512
Model No	: KEDID - 8070
Boyut / Size (mm)	: 800 x 740 x 850
Güç / Power(Kw)	: 7,2
Sıcaklık / Temperature (°c)	: 50 - 300
Voltaj / Voltage	: 400 V
Hacim / Volume(m ³)	: 0,55
Ağırlık / Weight(Kg)	: 95
Paket Ölç./Pkg Dim(mm)	: 900 x 850 x 1100
Fiyat / Price €	: 1.370,00 €



- TR** * Kızartma yüzeyi önünde yağ toplama kanalı ve tahliyesi
 * Kızartma sırasında süzülen yağların biriktiği yağ çekmecesi mevcuttur.
 * 50-300 °C arası termostatik sıcaklık kontrolü.
 * Uzun ömürlü, kolay temizlenebilir ve hijyeniktir.
 * Cihaz altına dolap bağlantısı yapılabilir

- EN** * Oil canal and drain hole take place on the front side of the grill surface
 * Collecting drawer for the straining oil.
 * Thermostatic regulation of temperature between 50-300 °C.
 * Long life, easy cleaning, and hygienic due to its stainless steel construction.
 * Unit to be mounted on open base cupboards



Izgara Oluklu / Grill Ribbed

Kod / Code	: 807480522
Model No	: KEOID - 4070
Boyut / Size (mm)	: 400 x 740 x 850
Güç / Power(Kw)	: 3,6
Sıcaklık / Temperature (°c)	: 50 - 300
Voltaj / Voltage	: 400 V
Hacim / Volume(m ³)	: 0,26
Ağırlık / Weight(Kg)	: 55
Paket Ölç./Pkg Dim(mm)	: 500 x 850 x 1100
Fiyat / Price €	: 960,00 €



Izgara Oluklu / Grill Ribbed

Kod / Code	: 807880522
Model No	: KEOID - 8070
Boyut / Size (mm)	: 800 x 740 x 850
Güç / Power(Kw)	: 7,2
Sıcaklık / Temperature (°c)	: 50 - 300
Hacim / Volume(m ³)	: 0,55
Ağırlık / Weight(Kg)	: 95
Paket Ölç./Pkg Dim(mm)	: 900 x 850 x 1100
Fiyat / Price €	: 1.500,00 €



- TR** * Kızartma yüzeyi önünde yağ toplama kanalı ve tahliyesi
 * Kızartma sırasında süzülen yağların biriktiği yağ çekmecesi mevcuttur.
 * 50-300 °C arası termostatik sıcaklık kontrolü.
 * Uzun ömürlü, kolay temizlenebilir ve hijyeniktir.
 * Cihaz altına dolap bağlantısı yapılabilir

- EN** * Oil canal and drain hole take place on the front side of the grill surface
 * Collecting drawer for the straining oil.
 * Thermostatic regulation of temperature between 50-300 °C.
 * Long life, easy cleaning, and hygienic due to its stainless steel construction.
 * Unit to be mounted on open base cupboards



Izgara Lavataş / Lavastone Grill

Kod / Code	: 807480601
Model No	: KGLID - 4070
Boyut / Size (mm)	: 400 x 740 x 850
Güç / Power(Kw)	: 6,0
Tüketim / Consump. (m ³ /h - Kg/h)	: 0,634 - 0,472
Hacim / Volume(m ³)	: 0,26
Ağırlık / Weight(Kg)	: 67
Paket Ölç./Pkg Dim(mm)	: 500 x 850 x 1100
Fiyat / Price €	: 770,00 €



Izgara Lavataş / Lavastone Grill

Kod / Code	: 807880601
Model No	: KGLID - 8070
Boyut / Size (mm)	: 800 x 740 x 850
Güç / Power(Kw)	: 12,0
Tüketim / Consump. (m ³ /h - Kg/h)	: 1,268 - 0,945
Hacim / Volume(m ³)	: 0,55
Ağırlık / Weight(Kg)	: 112
Paket Ölç./Pkg Dim(mm)	: 900 x 850 x 1100
Fiyat / Price €	: 1.260,00 €



- TR** * Lpg ve Doğalgaz ile çalışır.
 * Her brülör için kazayla sönmeye karşı gaz kesme kiti ve pilot içeren magnet emniyet ventilli gaz muslukları bulunur.
 * Kızartma yüzeyi önünde yağ toplama kanalı ve tahliyesi mevcuttur.
 * Kızartma sırasında süzülen yağların biriktiği yağ çekmecesi vardır.
 * Kontrol panelinde pilot alevini kontrol etmek için açıklık bulunur
 * Cihaz altına dolap bağlantısı yapılabilir

- EN** * Can be operated with Lpg and Ng gas.
 * Magnet ventill gas valves with flame failure device and pilot on each burner protect against gas leakage when accidental extinguishing of the flame occurs.
 * Oil canal and drain hole take place on the front side of the grill surface
 * Collecting drawer for the straining oil.
 * An opening takes place on the control panel to check the pilot flame situation
 * Unit to be mounted on open base cupboards



Izgara Sulu Döküm / Lavastone Water Grill 

Kod / Code : 807481601
Model No : KGSID-4070
Boyut / Size (mm) : 400 x 740 x 850
Güç / Power(Kw) : 6,0
Tüketim / Consump. (m³/h - Kg/h) : 0,634 - 0,472
Hacim / Volume(m³) : 0,26
Ağırlık / Weight(Kg) : 67
Paket Ölç./Pkg Dim(mm) : 500 x 850 x 1100
Fiyat / Price € : 995,00 €



Izgara Sulu Lavatařlı / Lavastone Water Grill 

Kod / Code : 807881601
Model No : KGSID-8070
Boyut / Size (mm) : 800 x 740 x 850
Güç / Power(Kw) : 12,0
Tüketim / Consump. (m³/h - Kg/h) : 1,268 - 0,945
Hacim / Volume(m³) : 0,55
Ağırlık / Weight(Kg) : 112
Paket Ölç./Pkg Dim(mm) : 900 x 850 x 1100
Fiyat / Price € : 1.500,00 €



- TR** * Lpg ve Doğalgaz ile çalışır.
* Her brülör için kazayla sönmeye karşı gaz kesme kiti ve pilot içeren magnet emniyet ventilli gaz muslukları bulunur.
* Kızartma yüzeyi önünde yağ toplama kanalı ve tahliyesi mevcuttur.
* Kızartma sırasında süzölen yağların biriktiđi yağ çekmecesine vardır.
* Kontrol panelinde pilot alevini kontrol etmek için açıklık bulunur
* Cihaz altına dolap bađlantısı yapılabilir

- EN** * Can be operated with Lpg and Ng gas.
* Magnet ventil gas valves with flame failure device and pilot on each burner protect against gas leakage when accidental extinguishing of the flame occurs.
* Oil canal and drain hole take place on the front side of the grill surface
* Collecting drawer for the straining oil.
* An opening takes place on the control panel to check the pilot flame situation
* Unit to be mounted on open base cupboards



Wok Ocak / Wok Cooker 

Kod / Code : 807481201
Model No : KGWD - 4070
Boyut / Size (mm) : 400 x 740 x 850
Güç / Power(Kw) : 18,00
Tüketim / Consump. (m³/h - Kg/h) : 1,268 - 0,945
Hacim / Volume(m³) : 0,46
Ağırlık / Weight(Kg) : 56,5
Paket Ölç./Pkg Dim(mm) : 500 x 850 x 1100
Fiyat / Price € : 1.100,00 €



Makarna Hařlama / Pasta Cooker 

Kod / Code : 807480202
Model No : KEMD - 4070
Boyut / Size (mm) : 400 x 740 x 850
Güç / Power(Kw) : 6,0
Sıcaklık / Temperature (°c) : 30 - 120
Kapasite / Capacity (Lt.) : 18
Voltaj / Voltage : 400 V
Hacim / Volume(m³) : 0,26
Ağırlık / Weight(Kg) : 47
Paket Ölç./Pkg Dim(mm) : 500 x 850 x 1100
Fiyat / Price € : 1.160,00 €





Patates Dinlendirme / Chips Scuttle

Kod / Code : 807480402
Model No : KEPD - 4070
Boyut / Size (mm) : 400 x 740 x 850
Güç / Power(Kw) : 1,0
Kapasite / Capacity (Lt.) : GN 1/1 150
Voltaj / Voltage : 230 V
Hacim / Volume(m³) : 0,26
Ağırlık / Weight(Kg) : 42
Paket Ölç./Pkg Dim(mm) : 500 x 850 x 1100
Fiyat / Price € : 760,00 €

Bain Marie / Bain Marie

Kod / Code : 807480302
Model No : KESBD - 4070
Boyut / Size (mm) : 400 x 740 x 850
Güç / Power(Kw) : 1,5
Kapasite : GN 1/1 150
Hacim / Volume(m³) : 0,26
Sıcaklık / Temperature(°c) : 30 - 120
Voltaj / Voltage : 230 V
Ağırlık / Weight(Kg) : 44
Paket Ölç./Pkg Dim(mm) : 500 x 850 x 1100
Fiyat / Price € : 695,00 €



Nötr Ara Tezgah / Neutral Worktop Unit

Kod / Code : 807480000
Model No : KATD - 4070
Boyut / Size (mm) : 400 x 740 x 850
Hacim / Volume(m³) : 0,26
Ağırlık / Weight(Kg) : 35
Paket Ölç./Pkg Dim(mm) : 500 x 850 x 1100
Fiyat / Price € : 390,00 €



Nötr Ara Tezgah / Neutral Worktop Unit

Kod / Code : 807880000
Model No : KATD - 8070
Boyut / Size (mm) : 800 x 740 x 850
Hacim / Volume(m³) : 0,55
Ağırlık / Weight(Kg) : 53
Paket Ölç./Pkg Dim(mm) : 900 x 850 x 1100
Fiyat / Price € : 580,00 €



Nötr Ara Tezgah / Neutral Worktop Unit

KOD Code	MODEL Model	Boyut Size	Hacim Volume m ³	Ağırlık Weight Kg.	Paket Ölç. Pkg. Dim mm	FİYAT PRICE €
807830000	KAT-8070	800x740x300	0,55	53	900x850x530	330,00
807430000	KAT-4070	400x740x300	0,55	35	500x850x530	280,00
807330000	KAT-3070	300x740x300	0,55	30	400x850x530	220,00
807230000	KAT-2070	200x740x300	0,55	25	300x850x530	200,00





Setaltı Tezgah / Under Counter Table

Kod / Code	: 807450000
Model No	: KAD - 4070
Boyut / Size (mm)	: 400 x 730 x 550
Hacim / Volume(m ³)	: 0,17
Ağırlık / Weight(Kg)	: 20
Paket Ölç./Pkg Dim(mm)	: 500 x 830 x 650
Fiyat / Price €	: 170,00 €



Setaltı Tezgah / Under Counter Table

Kod / Code	: 807850000
Model No	: KAD - 8070
Boyut / Size (mm)	: 800 x 730 x 550
Hacim / Volume(m ³)	: 0,32
Ağırlık / Weight(Kg)	: 30
Paket Ölç./Pkg Dim(mm)	: 900 x 830 x 650
Fiyat / Price €	: 280,00 €



Cihaz Dolap Kapısı Door for Cooking Series

Kod / Code	: P1001000001
Fiyat / Price €	: 100,00 €

Piřiriciler 900 Seri

Cookers 900 Series



www.kayalarmutfak.com.tr

444 5 957





Ocak / Cooker

Kod / Code	: 809480701
Model No	: KGOD-4090
Boyut / Size (mm)	: 400 x 930 x 850
Güç / Power(Kw)	: 14,5
Tüketim / Consump. (m ³ /h - Kg/h)	: 1,532 - 1,142
Hacim / Volume(m ³)	: 0,58
Ağırlık / Weight(Kg)	: 65
Paket Ölç./Pkg Dim(mm)	: 500 x 1050 x 1100
Fiyat / Price €	: 1.325,00 €

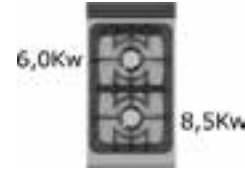

Ocak / Cooker

Kod / Code	: 809880701
Model No	: KGOD-8090
Boyut / Size (mm)	: 800 x 930 x 850
Güç / Power(Kw)	: 29,0
Tüketim / Consump. (m ³ /h - Kg/h)	: 3,065 - 2,285
Hacim / Volume(m ³)	: 1,03
Ağırlık / Weight(Kg)	: 90
Paket Ölç./Pkg Dim(mm)	: 900 x 1050 x 1100
Fiyat / Price €	: 1.840,00 €



TR

- * Lpg ve Doğalgaz ile çalışır.
- * Brülörler primer ve seconder yanma özelliği sayesinde yüksek yanma veriminin yanında düşük atık gaz emisyonu ile dünya standartlarında ve çevrecidir.
- * Her brülör için kazayla sönmeye karşı gaz kesme kiti ve pilot içeren magnet emniyet ventilli gaz muslukları bulunur.
- * Değişik ölçülerde tencere kullanımına olanak sağlayacak şekilde tasarlanmış , ağır hizmet tipi ocak dökümleri teflon kaplıdır
- * Tek parça basılmış AISI 304 kalite paslanmaz çelik üst tabla
- * Derin çekme ocak tepleri üst tabladan bağımsız olup , temizliğe en hızlı ve kolay çözümü getirirken, hijyenik bir pişirme alanı sağlar

EN

- * Can be operated with Lpg and Ng gas.
- * The gas burners provides a high burning fertility through primary and secondary burning and is proper to the world standart
- * Magnet ventil gas valves with flame failure device and pilot on each burner protect against gas leakage when accidental extinguishing of the flame occurs.
- * Teflon coated ,hard pan support in cast iron specially designed to provide usage of different sized pans.
- * One piece pressed AISI 304 stainless steel worktop
- * Deep formed cooking departments bring fastest and ease of cleaning, assuring hygenic cooking area



Ocak / Cooker

Kod / Code	: 809480702
Model No	: KEOD-4090
Boyut / Size (mm)	: 400 x 930 x 850
Güç / Power(Kw)	: 6,0
Voltaj / Voltage	: 400 V
Sıcaklık / Temperature (°c)	: 50-300
Hacim / Volume(m ³)	: 0,58
Ağırlık / Weight(Kg)	: 85
Paket Ölç./Pkg Dim(mm)	: 500 x 1050 x 1100
Fiyat / Price €	: 1.100,00 €

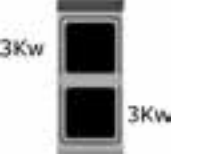

Ocak / Cooker

Kod / Code	: 809880702
Model No	: KEOD-8090
Boyut / Size (mm)	: 800 x 930 x 850
Güç / Power(Kw)	: 12,0
Voltaj / Voltage	: 400 V
Sıcaklık / Temperature (°c)	: 50-300
Hacim / Volume(m ³)	: 1,03
Ağırlık / Weight(Kg)	: 108
Paket Ölç./Pkg Dim(mm)	: 900 x 1050 x 1100
Fiyat / Price €	: 1.880,00 €

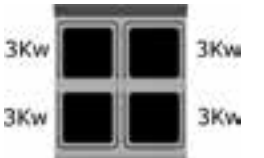

TR

- * Birbirinden bağımsız olarak ısıtıcıların her biri kademeli şalter kontrolü ile çalışmaktadır.
- * Tek parça basılmış üst tabla
- * Kullanıcıya her yönden rahatlık sağlayan ergonomik dizayna sahiptir.
- * Sağlam konstrüksiyonu ile emniyetli kullanım sağlar.
- * Cihaz altına dolap bağlantısı yapılabilir

EN

- * Each of the heaters can be operated separately by gradeted switches.
- * One piece pressed worktop
- * Ergonomical design provides comfort to the user
- * Safe usage through solid construction
- * Unit to be mounted on open base cupboards



Kuzine Fırnı / Range With Oven

Kod / Code	: 809880802
Model No	: KEKF-8090
Boyut / Size (mm)	: 800 x 930 x 850
Güç / Power(Kw)	: 16,8
Voltaj / Voltage	: 400 V
Sıcaklık / Temperature (°c)	: 50-300
Hacim / Volume(m³)	: 1,03
Ağırlık / Weight(Kg)	: 160
Paket Ölç./Pkg Dim(mm)	: 900 x 1050 x 1100
Fiyat / Price €	: 2.425,00 €



Kuzine Fırnı / Range With Oven

Kod / Code	: 809180802
Model No	: KEKFD-1290
Boyut / Size (mm)	: 1200 x 930 x 850
Güç / Power(Kw)	: 3x6 + 4,8 = 22,8
Voltaj / Voltage	: 400 V
Sıcaklık / Temperature (°c)	: 50-300
Hacim / Volume(m³)	: 1,00
Ağırlık / Weight(Kg)	: 208
Paket Ölç./Pkg Dim(mm)	: 1300 x 1050 x 1100
Fiyat / Price €	: 3.425,00 €

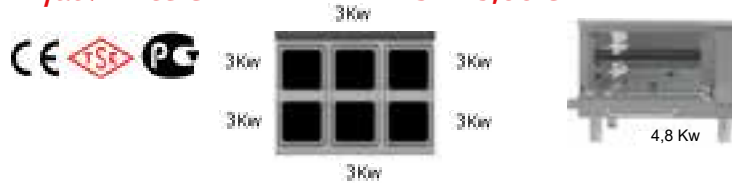

- TR** * Birbirinden bağımsız olarak ısıtıcıların her biri kademeli şalter kontrolü ile çalışmaktadır.
 * Tek parça basılmış AISI 304 kalite paslanmaz çelik üst tabla
 * Kullanıcıya her yönden rahatlık sağlayan ergonomik dizayna sahiptir.
 * Sağlam konstrüksiyonu ile emniyetli kullanım sağlar.
 * Fırın kapısı menteşe sistemi tek kollu olup maksimum güvenlik sağlamanın yanında iki kademeli menteşe sistemi kapı seviyelendirmesi imkanı sayesinde kullanım kolaylığı sağlar
 * Yekpare fırın gövdesi paslanmaz çelikten üretilmiştir ve fırın iç sıcaklığı termostatik olarak
 * 50 - 300 °C arası kontrol edilebilir.
 * Fırın kısmı GN 2/1 tepsi kapasiteli ve farklı konumlarda tepsi yerleştirme özelliğine sahiptir.

- EN** * Each of to heaters can be operated separately by graded switches.
 * One piece pressed AISI 304 stainless steel worktop
 * Ergonomical design provides comfort to the user.
 * Strong body construction brings safety usage.
 * Two leveled oven hinge system with single arm brings maximum safety in usage plus leveling the door brings ease of usage.
 * Monoblock oven body made of stainless steel and internal oven temperature controlled by thermostatically between 50 - 300 °C
 * Oven has GN 2/1 Capacity and accommodate different levels.



Kuzine Fırnı / Range With Oven

Kod / Code	: 809880801
Model No	: KGKF-8090
Boyut / Size (mm)	: 800 x 930 x 850
Güç / Power(Kw)	: 37,0
Tüketim / Consump. (m³/h - Kg/h)	: 3,911 - 2,915
Sıcaklık / Temperature (°c)	: 50-300 (Fırın)
Hacim / Volume(m³)	: 1,03
Ağırlık / Weight(Kg)	: 145
Paket Ölç./Pkg Dim(mm)	: 900 x 1050 x 1100
Fiyat / Price €	: 2.425,00 €

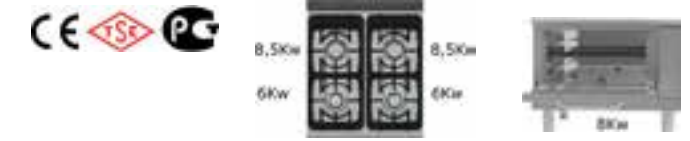

Kuzine Fırnı / Range With Oven

Kod / Code	: 809180801
Model No	: KGKFD-1290
Boyut / Size (mm)	: 1200 x 930 x 850
Güç / Power(Kw)	: 3x(6+8,5)+8=51,5
Tüketim / Consump. (m³/h - Kg/h)	: 5,443 - 4,058
Sıcaklık / Temperature (°c)	: 50-300 (Fırın)
Hacim / Volume(m³)	: 1,00
Ağırlık / Weight(Kg)	: 195
Paket Ölç./Pkg Dim(mm)	: 1300 x 1050 x 1100
Fiyat / Price €	: 3.475,00 €

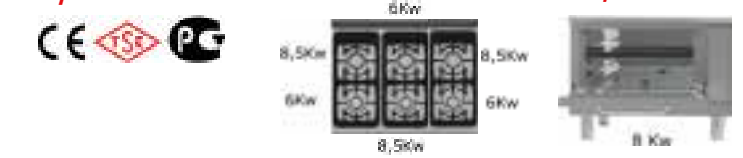

- TR** * Lpg ve Doğalgaz ile çalışır.
 * Brülörler primer ve sekunder yanma özelliği sayesinde yüksek yanma veriminin yanında düşük atık gaz emisyonu ile dünya standartlarında ve çevrecidir.
 * Her brülör için kazayla sönmeye karşı gaz kesme kiti ve pilot içeren magnet emniyet ventilli gaz muslukları bulunur.
 * Değişik ölçülerde tencere kullanımına olanak sağlayacak şekilde tasarlanmış, ağır hizmet tipi ocak dökümleri teflon kaplıdır
 * Tek parça basılmış AISI 304 kalite paslanmaz çelik üst tabla
 * Derin çekme ocak tepsiyi üst tabladan bağımsız olup, temizliğe en hızlı ve kolay çözümü getirirken, hijyenik bir pişirme alanı sağlar
 * Fırın kapısı menteşe sistemi tek kollu olup maksimum güvenlik sağlamanın yanında iki kademeli menteşe sistemi kapı seviyelendirmesi imkanı sayesinde kullanım kolaylığı sağlar
 * Yekpare fırın gövdesi paslanmaz çelikten üretilmiştir ve fırın iç sıcaklığı magnet ventilli gaz valfi tarafından maksimum 300 °C sıcaklığa kadar 8 ayrı kademede kontrol edilebilir.
 * Fırın kısmı GN 2/1 tepsi kapasiteli ve farklı konumlarda tepsi yerleştirme özelliğine sahiptir.

- EN** * Can be operated with Lpg and Ng gas.
 * The gas burners provides a high burning fertility through primary and secondary burning and is proper to the world standart
 * Magnet ventil gas valves with flame failure device and pilot on each burner protect against gas leakage when accidental extinguishing of the flame occurs.
 * Teflon coated ,hard pan support in cast iron specially designed to provide usage of different sized pans.
 * One piece pressed AISI 304 stainless steel worktop
 * Deep formed cooking departments bring fastest and ease of cleaning, assuring hygenic cooking area
 * Two leveled oven hinge system with single arm brings maximum safety in usage plus leveling the door brings ease of usage.
 * Monoblock oven body made of stainless steel and internal oven temperature controlled by thermostatic magnet ventil gas valve with eight levels maximum 300 °C
 * Oven has GN 2/1 Capacity and accommodate different levels.



Ocak Dolaplı/Range Cupboard

Kod / Code	: 809180702
Model No	: KEOD-1290
Boyut / Size (mm)	: 1200 x 930 x 850
Güç / Power(Kw)	: 18,0
Voltaj / Voltage	: 400 V
Hacim / Volume(m ³)	: 1,00
Ağırlık / Weight(Kg)	: 160
Paket Ölç./Pkg Dim(mm)	: 1300 x 1050 x 1100
Fiyat / Price €	: 2.760,00 €

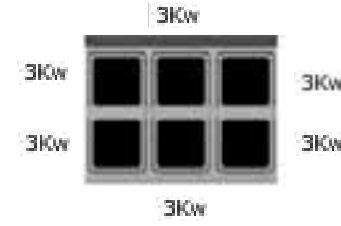

Ocak Dolaplı/Range Cupboard

Kod / Code	: 809180701
Model No	: KGOD-1290
Boyut / Size (mm)	: 1200 x 930 x 850
Güç / Power(Kw)	: 3x(6+8,5)= 43,5
Tüketim / Consump. (m ³ /h - Kg/h)	: 4,598 - 3,427
Hacim / Volume(m ³)	: 1,00
Ağırlık / Weight(Kg)	: 195
Paket Ölç./Pkg Dim(mm)	: 1300 x 1050 x 1100
Fiyat / Price €	: 2.860,00 €

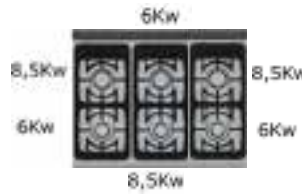

Fritöz/Deep Fryer

Kod / Code	: 809480102
Model No	: KEFD - 4090
Boyut / Size (mm)	: 400 x 930 x 850
Güç / Power(Kw)	: 15
Sıcaklık / Temperature (°c)	: 100 - 180
Voltaj / Voltage	: 400 V
Kapasite / Capacity (Lt)	: 30
Hacim / Volume(m ³)	: 0,58
Ağırlık / Weight(Kg)	: 60
Paket Ölç./Pkg Dim(mm)	: 500 x 1050 x 1100
Fiyat / Price €	: 1.370,00 €



Fritöz/Deep Fryer

Kod / Code	: 809880102
Model No	: KEFD - 8090
Boyut / Size (mm)	: 800 x 930 x 850
Güç / Power(Kw)	: 15+15 = 30
Sıcaklık / Temperature (°c)	: 100 - 180
Voltaj / Voltage	: 400 V
Kapasite / Capacity (Lt)	: 30 + 30
Hacim / Volume(m ³)	: 1,03
Ağırlık / Weight(Kg)	: 88
Paket Ölç./Pkg Dim(mm)	: 900 x 1050 x 1100
Fiyat / Price €	: 2.415,00 €



- TR** * Isıtıcılar, temizleme ve bakım kolaylığı için kaldırılabilir şekilde ve ısıyı homojen yayacak biçimde tasarlanmıştır
 * Yağ sıcaklığının maksimum 180 °C' e kadar termostatik kontrolü
 * Yağın aşırı ısınması durumunda limit termostat ısıtıcıları devre dışı bırakır ve emniyetli çalışma sağlar.
 * Uzun ömürlü, kolay temizlenebilir ve hijyeniktir.
 * Havuzdan yağın boşaltılması için önde 3/4" küresel vana
 * Maksimum güvenliği sağlamak için ; temizlik ve bakım esnasında ısıtıcı sistemi yukarıdayken , ısıtıcı enerjisini kesen sistem cihaza dahil edilmiştir.
 * Cihaz altına dolap bağlantısı yapılabilir

- EN** * Lifiable heating system with resistances designed for homogeneous heat distribution, provides easy cleaning and maintenance.
 * Thermostatic regulation of oil temperature up to a maximum of 180 °C.
 * In case of over heating of the oil , limit thermostat stops the heating elements and provides safety operate.
 * Long life, easy cleaning, and hygienic due to its stainless steel construction.
 * Spherical valve to drain oil from the container included on the front side
 * Safety system shutting off energy of the heaters included, to provide maximum safety through maintenance and cleaning while heat system lifted up



Fritöz/Deep Fryer



Kod / Code	: 809480101
Model No	: KGFD - 4090
Boyut / Size (mm)	: 400 x 930 x 850
Güç / Power(Kw)	: 18
Sıcaklık / Temperature (°c)	: 100 - 180
Tüketim / Consump. (m³/h - Kg/h)	: 1,902 - 1,418
Kapasite / Capacity (Lt)	: 30
Hacim / Volume(m³)	: 0,57
Ağırlık / Weight(Kg)	: 60
Paket Ölç./Pkg Dim(mm)	: 500 x 1050 x 1100
Fiyat / Price €	: 1.545,00 €



Fritöz/Deep Fryer



Kod / Code	: 809880101
Model No	: KGFD - 8090
Boyut / Size (mm)	: 800 x 930 x 850
Güç / Power(Kw)	: 18+18 = 36
Sıcaklık / Temperature (°c)	: 100 - 180
Tüketim / Consump. (m³/h - Kg/h)	: 3,805 - 2,836
Kapasite / Capacity (Lt)	: 30 + 30
Hacim / Volume(m³)	: 1,03
Ağırlık / Weight(Kg)	: 108
Paket Ölç./Pkg Dim(mm)	: 900 x 1050 x 1100
Fiyat / Price €	: 2.425,00 €



- TR** * Lpg ve Doğalgaz ile çalışır.ısıtıcılar, temizleme ve bakım kolaylığı için kaldırılabilir şekilde ve ısıyı homojen yayacak biçimde tasarlanmıştır
- * Yağ sıcaklığının maksimum 180 °C' e kadar termostatik kontrolü
- * Yağın aşırı ısınması durumunda limit termostat ısıtıcılar devre dışı bırakır ve emniyetli çalışma sağlar.
- * Uzun ömürlü, kolay temizlenebilir ve hijyeniktir.
- * Havuzdan yağın boşaltılması için 3/4" küresel vana Maksimum güvenliği sağlamak için ; temizlik ve bakım esnasında ısıtıcı sistemi yukarıdayken , ısıtıcı enerjisini kesen sistem cihaza dahil edilmiştir.
- * Dolapların kapı yönü değişebilir

- EN** * Can be operated with LPG and NG Gas
- * Lifiable heating system with resistances designed for homogeneous heat distribution, provides easy cleaning and maintenance
- * Thermostatic regulation of oil temperature up to a maximum of 180 °C
- * In case of over heating of the oil, limit thermostat stops the heating elements and provides safety operate.
- * Long life, easy cleaning and hygienic due to its
- * Spherical valve to drain oil from the container
- * Safety system shutting off energy of the heaters



Izgara Düz / Grill Smooth



Kod / Code	: 809480511
Model No	: KGDID - 4090
Boyut / Size (mm)	: 400 x 930 x 850
Güç / Power(Kw)	: 9,0
Tüketim / Consump. (m³/h - Kg/h)	: 0,951 - 0,709
Hacim / Volume(m³)	: 0,58
Ağırlık / Weight(Kg)	: 72
Paket Ölç./Pkg Dim(mm)	: 500 x 1050 x 1100
Fiyat / Price €	: 970,00 €



Izgara Düz / Grill Smooth



Kod / Code	: 809880511
Model No	: KGDID - 8090
Boyut / Size (mm)	: 800 x 930 x 850
Güç / Power(Kw)	: 18,0
Tüketim / Consump. (m³/h - Kg/h)	: 1,902 - 1,418
Hacim / Volume(m³)	: 1,03
Ağırlık / Weight(Kg)	: 121
Paket Ölç./Pkg Dim(mm)	: 900 x 1050 x 1100
Fiyat / Price €	: 1.660,00 €



- TR** * Lpg ve Doğalgaz ile çalışır.
- * Her brülör için kazayla sönmeye karşı gaz kesme kiti ve pilot içeren magnet emniyet ventilli gaz muslukları bulunur.
- * Kızartma yüzeyi önünde yağ toplama kanalı ve tahliyesi mevcuttur.
- * Kızartma sırasında süzülen yağların biriktiği yağ çekmecesi vardır.
- * Kontrol panelinde pilot alevini kontrol etmek için açıklık bulunur
- * Cihaz altına dolap bağlantısı yapılabilir

- EN** * Can be operated with Lpg and Ng gas.
- * Magnet ventil gas valves with flame failure device and pilot on each burner protect against gas leakage when accidental extinguishing of the flame occurs.
- * Oil canal and drain hole take place on the front side of the grill surface
- * Collecting drawer for the straining oil.
- * An opening takes place on the control panel to check the pilot flame situation
- * Unit to be mounted on open base cupboards



Izgara Oluklu / Grill Ribbed



Kod / Code	: 809480521
Model No	: KGOID - 4090
Boyut / Size (mm)	: 400 x 930 x 850
Güç / Power(Kw)	: 9,0
Tüketim / Consump. (m ³ /h - Kg/h)	: 0,951 - 0,709
Hacim / Volume(m ³)	: 0,58
Ağırlık / Weight(Kg)	: 72
Paket Ölç./Pkg Dim(mm)	: 500 x 1050 x 1100
Fiyat / Price €	: 1.050,00 €



Izgara Oluklu / Grill Ribbed



Kod / Code	: 809880521
Model No	: KGOID - 8090
Boyut / Size (mm)	: 800 x 930 x 850
Güç / Power(Kw)	: 18,0
Tüketim / Consump. (m ³ /h - Kg/h)	: 1,902 - 1,418
Hacim / Volume(m ³)	: 1,03
Ağırlık / Weight(Kg)	: 121
Paket Ölç./Pkg Dim(mm)	: 900 x 1050 x 1100
Fiyat / Price €	: 1.840,00 €



TR

- * Lpg ve Doğalgaz ile çalışır.
- * Her brülör için kazayla sönmeye karşı gaz kesme kiti ve pilot içeren magnet emniyet ventilli gaz muslukları bulunur.
- * Kızartma yüzeyi önünde yağ toplama kanalı ve tahliyesi mevcuttur.
- * Kızartma sırasında süzülen yağların biriktiği yağ çekmecesi vardır.
- * Kontrol panelinde pilot alevini kontrol etmek için açıklık bulunur
- * Cihaz altına dolap bağlantısı yapılabilir

EN

- * Can be operated with Lpg and Ng gas.
- * Magnet ventil gas valves with flame failure device and pilot on each burner protect against gas leakage when accidental extinguishing of the flame occurs.
- * Oil canal and drain hole take place on the front side of the grill surface
- * Collecting drawer for the straining oil.
- * An opening takes place on the control panel to check the pilot flame situation
- * Unit to be mounted on open base cupboards



Izgara 1/2 Oluklu / 1/2 Grill Ribbed



Kod / Code	: 809880531
Model No	: KGYID - 8090
Boyut / Size (mm)	: 800 x 930 x 850
Güç / Power(Kw)	: 18,00
Tüketim / Consump. (m ³ /h - Kg/h)	: 1,902 - 1,418
Hacim / Volume(m ³)	: 1,03
Ağırlık / Weight(Kg)	: 122
Paket Ölç./Pkg Dim(mm)	: 900 x 1050 x 1100
Fiyat / Price €	: 1.630,00 €



Izgara 1/2 Oluklu / 1/2 Grill Ribbed



Kod / Code	: 809880532
Model No	: KEYID - 8090
Boyut / Size (mm)	: 800 x 930 x 850
Güç / Power(Kw)	: 12,0
Sıcaklık / Temperature (°c)	: 50 - 300
Hacim / Volume(m ³)	: 1,03
Voltaj / Voltage	: 400 V
Ağırlık / Weight(Kg)	: 110
Paket Ölç./Pkg Dim(mm)	: 900 x 850 x 1100
Fiyat / Price €	: 1.630,00 €



TR

- * Lpg ve Doğalgaz ile çalışır.
- * Her brülör için kazayla sönmeye karşı gaz kesme kiti ve pilot içeren magnet emniyet ventilli gaz muslukları bulunur.
- * Kızartma yüzeyi önünde yağ toplama kanalı ve tahliyesi mevcuttur.
- * Kızartma sırasında süzülen yağların biriktiği yağ çekmecesi vardır.
- * Kontrol panelinde pilot alevini kontrol etmek için açıklık bulunur
- * Cihaz altına dolap bağlantısı yapılabilir

EN

- * Can be operated with Lpg and Ng gas.
- * Magnet ventil gas valves with flame failure device and pilot on each burner protect against gas leakage when accidental extinguishing of the flame occurs.
- * Oil canal and drain hole take place on the front side of the grill surface
- * Collecting drawer for the straining oil.
- * An opening takes place on the control panel to check the pilot flame situation
- * Unit to be mounted on open base cupboards



Izgara Düz / Grill Smooth

Kod / Code	: 809480512
Model No	: KEDID - 4090
Boyut / Size (mm)	: 400 x 930 x 850
Güç / Power(Kw)	: 6,0
Sıcaklık / Temperature (°c)	: 50 - 300
Voltaj / Voltage	: 400 V
Hacim / Volume(m³)	: 0,58
Ağırlık / Weight(Kg)	: 65
Paket Ölç./Pkg Dim(mm)	: 500 x 1050 x 1100
Fiyat / Price €	: 970,00 €



Izgara Oluklu / Grill Ribbed

Kod / Code	: 809480522
Model No	: KEOID - 4090
Boyut / Size (mm)	: 400 x 930 x 850
Güç / Power(Kw)	: 6,0
Sıcaklık / Temperature (°c)	: 50 - 300
Voltaj / Voltage	: 400 V
Hacim / Volume(m³)	: 0,58
Ağırlık / Weight(Kg)	: 65
Paket Ölç./Pkg Dim(mm)	: 500 x 1050 x 1100
Fiyat / Price €	: 1.060,00 €



Izgara Düz / Grill Smooth

Kod / Code	: 809880512
Model No	: KEDID - 8090
Boyut / Size (mm)	: 800 x 930 x 850
Güç / Power(Kw)	: 12,0
Sıcaklık / Temperature (°c)	: 50 - 300
Voltaj / Voltage	: 400 V
Hacim / Volume(m³)	: 1,03
Ağırlık / Weight(Kg)	: 110
Paket Ölç./Pkg Dim(mm)	: 900 x 1050 x 1100
Fiyat / Price €	: 1.650,00 €



Izgara Oluklu / Grill Ribbed

Kod / Code	: 809880522
Model No	: KEOID - 8090
Boyut / Size (mm)	: 800 x 930 x 850
Güç / Power(Kw)	: 12,0
Sıcaklık / Temperature (°c)	: 50 - 300
Hacim / Volume(m³)	: 1,03
Ağırlık / Weight(Kg)	: 110
Paket Ölç./Pkg Dim(mm)	: 900 x 1050 x 1100
Fiyat / Price €	: 1.840,00 €



- TR** * Kızartma yüzeyi önünde yağ toplama kanalı ve tahliyesi
 * Kızartma sırasında süzülen yağların biriktiği yağ çekmecesi mevcuttur.
 *50-300 °C arası termostatik sıcaklık kontrolü.
 *Uzun ömürlü, kolay temizlenebilir ve hijyeniktir.
 *Cihaz altına dolap bağlantısı yapılabilir

- EN** * Oil canal and drain hole take place on the front side of the grill surface
 * Collecting drawer for the straining oil.
 * Thermostatic regulation of temperature between 50-300 °C.
 * Long life, easy cleaning, and hygienic due to its stainless steel construction.
 * Unit to be mounted on open base cupboards

- TR** * Kızartma yüzeyi önünde yağ toplama kanalı ve tahliyesi
 * Kızartma sırasında süzülen yağların biriktiği yağ çekmecesi mevcuttur.
 *50-300 °C arası termostatik sıcaklık kontrolü.
 *Uzun ömürlü, kolay temizlenebilir ve hijyeniktir.
 *Cihaz altına dolap bağlantısı yapılabilir

- EN** * Oil canal and drain hole take place on the front side of the grill surface
 * Collecting drawer for the straining oil.
 * Thermostatic regulation of temperature between 50-300 °C.
 * Long life, easy cleaning, and hygienic due to its stainless steel construction.
 * Unit to be mounted on open base cupboards



Izgara Lavatař / Lavastone Grill

Kod / Code	: 809480601
Model No	: KGLID - 4090
Boyut / Size (mm)	: 400 x 930 x 850
Güç / Power(Kw)	: 9,0
Tüketim / Consump. (m ³ /h - Kg/h)	: 0,951 - 0,709
Hacim / Volume(m ³)	: 0,58
Ağırlık / Weight(Kg)	: 80
Paket Ölç./Pkg Dim(mm)	: 500 x 1050 x 1100
Fiyat / Price €	: 980,00 €



- TR** * Lpg ve Doğalgaz ile çalışır.
 * Her brülör için kazayla sönmeye karşı gaz kesme kiti ve pilot içeren magnet emniyet ventilli gaz muslukları bulunur.
 * Kızartma yüzeyi önünde yağ toplama kanalı ve tahliyesi mevcuttur.
 * Kızartma sırasında süzölen yağların biriktiği yağ çekmecesi vardır.
 * Kontrol panelinde pilot alevini kontrol etmek için açıklık bulunur
 * Cihaz altına dolap bağlantısı yapılabilir

- EN** * Can be operated with Lpg and Ng gas.
 * Magnet ventil gas valves with flame failure device and pilot on each burner protect against gas leakage when accidental extinguishing of the flame occurs.
 * Oil canal and drain hole take place on the front side of the grill surface
 * Collecting drawer for the straining oil.
 * An opening takes place on the control panel to check the pilot flame situation
 * Unit to be mounted on open base cupboards



Izgara Lavatař / Lavastone Grill

Kod / Code	: 809880601
Model No	: KGLID - 8090
Boyut / Size (mm)	: 800 x 930 x 850
Güç / Power(Kw)	: 18,0
Tüketim / Consump. (m ³ /h - Kg/h)	: 1,902 - 1,418
Hacim / Volume(m ³)	: 1,03
Ağırlık / Weight(Kg)	: 132
Paket Ölç./Pkg Dim(mm)	: 900 x 1050 x 1100
Fiyat / Price €	: 1.600,00 €



- TR** * Lpg ve Doğalgaz ile çalışır.
 * Her brülör için kazayla sönmeye karşı gaz kesme kiti ve pilot içeren magnet emniyet ventilli gaz muslukları bulunur.
 * Kızartma yüzeyi önünde yağ toplama kanalı ve tahliyesi mevcuttur.
 * Kızartma sırasında süzölen yağların biriktiği yağ çekmecesi vardır.
 * Kontrol panelinde pilot alevini kontrol etmek için açıklık bulunur
 * Cihaz altına dolap bağlantısı yapılabilir

- EN** * Can be operated with Lpg and Ng gas.
 * Magnet ventil gas valves with flame failure device and pilot on each burner protect against gas leakage when accidental extinguishing of the flame occurs.
 * Oil canal and drain hole take place on the front side of the grill surface
 * Collecting drawer for the straining oil.
 * An opening takes place on the control panel to check the pilot flame situation
 * Unit to be mounted on open base cupboards



Makama Hařlama / Pasta Cooker

Kod / Code	: 809480202
Model No	: KEMD - 4090
Boyut / Size (mm)	: 400 x 930 x 850
Güç / Power(Kw)	: 9,0
Sıcaklık / Temperature (°c)	: 30 - 120
Kapasite / Capacity (Lt.)	: 30
Voltaj / Voltage	: 400 V
Hacim / Volume(m ³)	: 0,58
Ağırlık / Weight(Kg)	: 49
Paket Ölç./Pkg Dim(mm)	: 500 x 1050 x 1100
Fiyat / Price €	: 1.440,00 €



- TR** * Isıtılan suyun sıcaklığı termostatik kumanda ile 30 -120 °C arası kontrol edilebilmektedir.
 * Havuzdan suyun boşaltılması için önde 3/4" küresel vana
 * Paslanmaz çelikten imal edilmiş sepetleri sayesinde pratik piřirme sağlar.
 * Paslanmaz çelik konstrüksiyonu ile uzun ömürlü, kolay temizlenebilir ve hijyeniktir
 * Cihaz altına dolap bağlantısı yapılabilir

- EN** * The temperature of water is controlled thermostatically between 30-120 °C
 * Spherical valve to drain water from the container included on the front side
 * Easy cooking through the stainless steel baskets.
 Durable, easy to clean and hygienic due to its stainless steel constuction.
 * Unit to be mounted on open base cupboards



Patates Dinlendirme / Chips Scuttle

Kod / Code	: 809480402
Model No	: KEPD - 4090
Boyut / Size (mm)	: 400 x 930 x 850
Güç / Power(Kw)	: 1,0
Kapasite / Capacity (Lt.)	: GN 1/1 150
Voltaj / Voltage	: 230 V
Hacim / Volume(m ³)	: 0,58
Ağırlık / Weight(Kg)	: 45
Paket Ölç./Pkg Dim(mm)	: 500 x 1050 x 1100
Fiyat / Price €	: 820,00 €



- TR** * GN 2/3 x 150 mm kap kapasiteli.
 * Ürün arkasında yer alan infrared seramik ısıtıcı, servis edilmeden önce servis edilecek gıdanın sıcak kalmasını sağlar
 * Kullanıcıya her yönden rahatlık sağlayan ergonomik dizayna sahip.
 * Süzgeç sacı vasıtasıyla patateslerin yağını süzme
 * Cihaz altına dolap bağlantısı yapılabilir

- EN** * 1/1 GN 150 mm container Capacity.
 * Unit to have infrared heating elements positioned on the back of the unit to keep servings warm until ready to be plated and served.
 * Ergonomical design provides comfort for the user.
 * Through perforated sheet metal part, easy draining potatoes
 * Unit to be mounted on open base cupboards



Bain Marie / Bain Marie

Kod / Code	: 809480302
Model No	: KESBD - 4090
Boyut / Size (mm)	: 400 x 930 x 850
Güç / Power(Kw)	: 1,5
Kapasite	: GN 1/1 150
Hacim / Volume(m ³)	: 0,58
Sıcaklık / Temperature(°c)	: 30 - 120
Voltaj / Voltage	: 230 V
Ağırlık / Weight(Kg)	: 48
Paket Ölç./Pkg Dim(mm)	: 500 x 1050 x 1100
Fiyat / Price €	: 840,00 €



Nötr Ara Tezgah / Neutral Worktop Unit

Kod / Code	: 809480000
Model No	: KATD - 4090
Boyut / Size (mm)	: 400 x 930 x 850
Hacim / Volume(m ³)	: 0,58
Ağırlık / Weight(Kg)	: 38
Paket Ölç./Pkg Dim(mm)	: 500 x 1050 x 1100
Fiyat / Price €	: 500,00 €



Nötr Ara Tezgah / Neutral Worktop Unit

Kod / Code	: 809880000
Model No	: KATD - 8090
Boyut / Size (mm)	: 800 x 930 x 850
Hacim / Volume(m ³)	: 1,03
Ağırlık / Weight(Kg)	: 48
Paket Ölç./Pkg Dim(mm)	: 900 x 1050 x 1100
Fiyat / Price €	: 725,00 €



Kaynatma Kazanı / Boiling Pan

KOD Code	ISITMA TIPI HEATING TYPE	KAPASİTE Capacity (Lt)	GÜÇ Power (kw)	EBAT Size (mm)	Fiyat Price €
809881001	INDIRECT	150	23	800 x 930 x 850	5.060,00
802981001	INDIRECT	250	26	900 x 1050 x 900	7.150,00
809881002	INDIRECT	150	12	800 x 930 x 850	4.730,00
802981002	INDIRECT	250	20	900 x 1050 x 900	6.930,00

- TR** * Cihaz gövdesi 18/8 Cr-Ni paslanmaz çelik taşı saçıtan üretilmiştir.
 * Kapak, mukavemet açısından özel form verilmiş paslanmaz çelik saçıtan üretilmiştir.
 * Benmari sistemi ile kazan çevresinde dolaşan yağ ile indirekt olarak pişirme yapar.
 * Çok kademeli termostat ile 60-180°C arasında sıcaklık ayar imkanına sahiptir.
 * Kazan çevresindeki (ceket) yağın kaynama sıcaklığı 200°C'nin üzerindedir.
 * Su doldurma (soğuk/sıcak) ve boşaltma vanaları cihaz üzerine montelidir.
 * Pişirilen malzemenin boşaltılması için özel şekillendirilmiş istem dışı açılmaları karşı emniyetli boşaltma vanası vardır.
 * Herhangi bir arıza olma durumunda otomatik olarak enerjiyi kesen emniyet sistemi (limit termostat)
 * Tüm elektrik / gaz kumanda ve kontrol donanımları uluslararası standartlara uygundur.
 * Isıtma Tipi: Indirekt

- EN** * Device body is made from 18/8 Cr-Ni stainless steel stone plate.
 * Cover is made from stainless steel plate which is special formed for endurance.
 * Indirect cooking is available with bain-marie system in which oil goes around pan.
 * Multi stage thermostat can adjust temperature between 60-180°C
 * Oil's, around pan (jacket), boiling temperature is over 200°C
 * Water filling (hot/cold) and draining valves are on the device.
 * There is a safety discharge valve for cooked material which is specially formed for undesirable openings
 * There is a safety system that cut the electricity if any malfunction occurs at pan (limited thermostat)
 * All electrical / gas and control equipment are suitable to international standards.
 * Heating type: Indirect



Devrilir Tava / Tilting Pan

KOD Code	MODEL	KAPASİTE Capacity (Lt)	GÜÇ Power (kw)	EBAT Size (mm)	Fiyat Price €
809880902	KEDT-8090	80	12,00	800 x 930 x 850	4.000,00
809980902	KEDT-9090	120	12,00	900 x 1050 x 900	4.250,00
802980902	KEDT-1250	250	27,00	1500 x 1000 x 850	8.000,00
809880901	KGDT-8090	80	18,00	800 x 930 x 850	4.000,00
809980901	KGDT-9090	120	18,00	900 x 1050 x 900	4.400,00

TR * Cihaz gövdesi 18/8 Cr-Ni paslanmaz çelik taşı saçtan üretilmiştir.
* Kapak, mukavemet açısından özel form verilmiş paslanmaz çelik saçtan çift cidarlı olarak üretilmiştir.
* Tava tabanı 12mm paslanmaz çelik saçtan üretilmiştir, böylece ısının homojen yayılması ve uzun süre muhafazası sağlanmıştır.
* Devirme tertibatı özel mekanizması ile kuvvet gerektirmeden kolaylıkla çevrilebilir yapıda ve devirme açısı 85 derecedir.
* Tavaya temizleme ya da kullanım amacıyla su doldurmak için sıcak ve soğuk su verebilen musluk montelidir.
* Çok kademeli termostat ile 50-3000C arasında sıcaklık ayar imkanına sahiptir.
* Tavada herhangi bir arıza olma durumunda otomatik olarak enerjiyi kesen emniyet sistemi (limit termostat) vardır.
* Tüm elektrik / gaz kumanda ve kontrol donanımları uluslararası standartlara uygundur.

EN * Device body is made from 18/8 Cr-Ni stainless steel stone plate.
* Cover is made from stainless steel plate which is special formed for endurance and double wall.
* Pan bottom is made from 12mm stainless steel plate, thus temperature can spread homogeneous and preserve longer.
* Overturn equipment with its special mechanism can be turned without force and overturn angle is 85.
* Pan has a tap for cleaning or usage for hot and cold water.
* Multi stage thermostat can adjust temperature between 50-300°C
* There is a safety system that cut the electricity if any malfunction occurs at pan (limited thermostat).
* All electrical / gas and control equipment are suitable to international standards.



**GAZLI KUZİNELER
GAS RANGE WITH OVEN**



KOD Code	MODEL Model	GİRİŞ Inlet	MODÜL Gross (m ²)	GÜÇ Power (kw)	ENERJİ Energy	EBAT Size (cm)	FİYAT PRICE €
801180801	KKFE-101	3/4"	1	40	LPG-NG/E	100 x 100 x 85	2.500,00



**PASTA BÖREK FIRINLARI
PASTRY & PIE OVENS**



KOD Code	MODEL Model	GİRİŞ Inlet	GÜÇ Power (kw)	ENERJİ Energy	EBAT Size (cm)	FİYAT PRICE €
805101202	KPBF-9090	1/2"	18	LPG-NG	100 x 100 x 160	1.850,00



**ELEKTRİKLİ YER OCAĞI
GROUND RANGE ELECTRICAL**



KOD Code	MODEL Model	GİRİŞ Inlet	GÜÇ Power (kw)	ENERJİ Energy	EBAT Size (cm)	FİYAT PRICE €
801650702	KYE	220-230 / 50-60HZ	5	ELEKTRİK	60 x 70 x 50	800,00



**GAZLI YER OCAĞI
GROUND RANGE WITH GAS**



KOD Code	MODEL Model	GİRİŞ Inlet	GÜÇ Power (kw)	ENERJİ Energy	EBAT Size (cm)	FİYAT PRICE €
801650703	KYG	1/2"	20	LPG	60 x 70 x 50	700,00
801650701	KNG	1/2"	20	NG	60 x 70 x 50	700,00



Fritöz/Deep Fryer



Kod / Code	: 803490151
Boyut / Size (mm)	: 400 x 768 x 933
Güç / Power(Kw)	: 22
Kapasite / Capacity (Lt)	: 35
Sıcaklık / Temperature (°c)	: 100 - 180
Hacim / Volume(m ³)	: 0,65
Ağırlık / Weight(Kg)	: 72
Paket Ölç./Pkg Dim(mm)	: 500 x 1050 x 1200
Fiyat / Price €	: 2.100,00 €



Fritöz/Deep Fryer



Kod / Code	: 803890151
Boyut / Size (mm)	: 800 x 768 x 933
Güç / Power(Kw)	: 22 + 22
Sıcaklık / Temperature (°c)	: 100 - 180
Kapasite / Capacity (Lt)	: 35 + 35
Hacim / Volume(m ³)	: 1,10
Ağırlık / Weight(Kg)	: 115
Paket Ölç./Pkg Dim(mm)	: 900 x 1050 x 1200
Fiyat / Price €	: 3.500,00 €



Fırınlar

Ovens



www.kayalarmutfak.com.tr

444 5 957





KONVEKSİYONLU FIRINLAR 6 TEPSİLİ

CONVECTION OVENS 6 TRAYS

KOD Code	MODEL	KAPASİTE Capacity	VOLTAJ Voltage	AĞIRLIK Weight (kg)	GÜÇ Power (kW)	ENERJİ ENERGY	EBAT Size (mm)	FİYAT PRICE €
99050150017	MKF-4	600 x 400 Tepsi/Tray	220V , 3N, 50 Hz	68	4,5	ELEKTRİK	800 x 810 x 567	2.400,00
99050150018	MKF-6E	6 x 1/1	380V , 3N, 50 Hz	102	9	ELEKTRİK	870 x 815 x 870	3.750,00

KONVEKSİYONLU FIRINLAR 10 TEPSİLİ

CONVECTION OVENS 10 TRAYS

KOD Code	MODEL	KAPASİTE Capacity	VOLTAJ	AĞIRLIK Weight (kg)	GÜÇ Power (kW)	ENERJİ	EBAT Size (mm)	FİYAT PRICE €
99050150011	MKF-10E	10 x 1/1	380V , 3N, 50Hz	133	14	ELEKTRİK	870 x 815 x 1195	5.300,00

KONVEKSİYONLU FIRINLAR 20 TEPSİLİ

CONVECTION OVENS 20 TRAYS

KOD Code	MODEL	KAPASİTE Capacity	VOLTAJ	AĞIRLIK Weight (kg)	GÜÇ Power (kW)	ENERJİ	EBAT Size (mm)	FİYAT PRICE €
99050150012	MKF-20E	10 x 2/1 20 x 1/1	220V , 1N, 50Hz	171	16	ELEKTRİK	950 x 1360 x 945	6.500,00
99050150013	MKF-20G	10 x 2/1 20 x 1/1	220V , 1N, 50Hz	186	16	GAZ	950 x 1360 x 945	6.800,00

KONVEKSİYONLU FIRINLAR 40 TEPSİLİ

CONVECTION OVENS 40 TRAYS

KOD Code	MODEL	KAPASİTE Capacity	VOLTAJ	AĞIRLIK Weight (kg)	GÜÇ Power (kW)	ENERJİ	EBAT / Size (mm)	FİYAT PRICE €
99050150015	MKF-40E	20 x 2/1 40 x 1/1	380V , 3N, 50Hz	257	32	ELEKTRİK	950 x 1360 x 1700	10.500,00
99050150016	MKF-40G	20 x 2/1 40 x 1/1	380V , 3N, 50/60Hz	257	32	GAZ	950 x 1360 x 1700	10.800,00
TEPSİ TAŞIMA ARABASI VE KİTİ / TROLLEY								1.000,00

KONVEKSİYONEL FIRINLAR YEMEK PİŞİRME SÜRELERİ
CONVECTION OVENS COOKING TIMES

YEMEK / DISH	TEPSİ / TRAY GN 2/1	C°	PİŞİRME SÜRESİ COOKING TIME Dakika / Min.
Fırında milföy böreği / Cannelloni in the oven	delikli 20mm	170-180	18-20
Fırında pizza / Pizza from the oven	delikli 20mm	180	15
Dana rosto / Roast veal	düz 65mm	170	100
Sığır eti rosto / Roast beef	düz 65mm	160	120
Biftek rosto / Roast steak	düz 65mm	180	30
Kuzu pizola / Lamb chops	ızgara	170	100
Bütün Kuzu tandır	Asarak	140	150
Bütün tavuk / Whole chicken	ızgara	160	70
Çeyrek tavuk / Quarter chicken	ızgara	170	55
Dana pizola / Cutlet	ızgara	200	12
Dil balığı filetosu / Fillet of sole	ızgara	160	15
Fırında alabalık / Baked trout	ızgara	160	20
Fırında somon / Salmon	ızgara	180	20
Lazanya	düz 60mm	170	45
Kabak dolma / Stuffed courgettes	düz 65mm	160	50
Puf böreği / Puff pastry	düz 20mm	160	20
Pandispanya / Sponge cakes	düz 20mm	170	20
Çörekler / Brioche	delikli 20mm	160	15



KONVEKSİYONLU FIRIN STANDLARI

CONVECTION OVEN STANDS

KOD Code	MODEL	AĞIRLIK Weight (kg)	EBAT Size (mm)	FİYAT PRICE €
901020000	6-10GN 1/1	27	900 x 745 x 650	600,00
901050000	10-GN 2/1	45	110 x 1110 x 650	700,00

PİZZA FIRINLARI / PİZZA OVENS

ANALOG ELEKTRİKLİ PİZZA FIRINLARI
ANALOG PIZZA OVENS WITH ELECTRICAL

Ø30 CM PİZZA	KOD Code	MODEL	KAPASİTE Capacity	DIŞ EBAT Ext. Size (mm)	İÇ EBAT Int. Size (mm)	GÜÇ Power (Kw)	AĞIRLIK Weight (kg)	FİYAT PRICE €
	99050150035	E4301A (Tek Katlı)	4 Pizza	1010 x 800 x 425	620 x 620 x 130	4,2 / 400V	90	1.685,00
	99050150037	E4302A (Çift Katlı)	4+4 Pizza	1010 x 800 x 750	620 x 620 x 130	8,4 / 400V	170	3.160,00
	99050150057	E6301DA (Tek Katlı)	6 Pizza	1010 x 1110 x 425	620 x 930 x 130	7,2 / 400V	120	2.380,00
	99050150038	E6302DA (Çift Katlı)	6+6 Pizza	1010 x 1110 x 750	620 x 930 x 130	14,4 / 400V	220	3.830,00
	99050150061	E6301WA (Tek Katlı)	6 Pizza	1320 x 800 x 425	930 x 620 x 130	7,8 / 400V	125	2.300,00
	99050150039	E6302WA (Çift Katlı)	6+6 Pizza	1320 x 800 x 750	930 x 620 x 130	15,6 / 400V	225	4.175,00

Ø35 CM PİZZA	KOD Code	MODEL	KAPASİTE Capacity	DIŞ EBAT Ext. Size (mm)	İÇ EBAT Int. Size (mm)	GÜÇ Power (Kw)	AĞIRLIK Weight (kg)	FİYAT PRICE €
	99050150036	E4351A (Tek Katlı)	4 Pizza	1110 x 900 x 420	720 x 720 x 130	5,1 / 400V	95	2.180,00
	99050150060	E4352A (Çift Katlı)	4+4 Pizza	1110 x 900 x 750	720 x 720 x 130	10,2 / 400V	180	3.690,00
	99050150058	E6351DA (Tek Katlı)	6 Pizza	1110 x 1260 x 420	720 x 1080 x 130	7,8 / 400V	125	2.685,00
	99050150040	E6352DA (Çift Katlı)	6+6 Pizza	1110 x 1260 x 750	720 x 1080 x 130	15,6 / 400V	225	4.400,00
	99050150059	E6351WA (Tek Katlı)	6 Pizza	1470 x 900 x 420	1080 x 720 x 130	10,0 / 400V	130	2.785,00
	99050150041	E6352WA (Çift Katlı)	6+6 Pizza	1470 x 900 x 750	1080 x 720 x 130	20,0 / 400V	230	4.740,00

DİJİTAL ELEKTRİKLİ PİZZA FIRINLARI
DİJİTAL PIZZA OVENS WITH ELECTRICAL

Ø30 CM PİZZA	KOD Code	MODEL	KAPASİTE Capacity	DIŞ EBAT Ext. Size (mm)	İÇ EBAT Int. Size (mm)	GÜÇ Power (Kw)	AĞIRLIK Weight (kg)	FİYAT PRICE €
	99050150049	E4301 (Tek Katlı)	4 Pizza	1010 x 800 x 425	620 x 620 x 130	4,2 / 400V	90	2.035,00
	99050150050	E4302 (Çift Katlı)	4+4 Pizza	1010 x 800 x 750	620 x 620 x 130	8,4 / 400V	170	3.690,00
	99050150062	E6301D (Tek Katlı)	6 Pizza	1010 x 1110 x 425	620 x 930 x 130	7,2 / 400V	120	2.685,00
	99050150063	E6302D (Çift Katlı)	6+6 Pizza	1010 x 1110 x 750	620 x 930 x 130	14,4 / 400V	220	4.565,00
	99050150064	E6301W (Tek Katlı)	6 Pizza	1320 x 800 x 425	930 x 620 x 130	7,8 / 400V	125	2.610,00
	99050150065	E6302W (Çift Katlı)	6+6 Pizza	1320 x 800 x 750	930 x 620 x 130	15,6 / 400V	225	4.650,00

Ø35 CM PİZZA	KOD Code	MODEL	KAPASİTE Capacity	DIŞ EBAT Ext. Size (mm)	İÇ EBAT Int. Size (mm)	GÜÇ Power (Kw)	AĞIRLIK Weight (kg)	FİYAT PRICE €
	99050150066	E4351 (Tek Katlı)	4 Pizza	1110 x 900 x 420	720 x 720 x 130	5,1 / 400V	95	2.415,00
	99050150045	E4352 (Çift Katlı)	4+4 Pizza	1110 x 900 x 750	720 x 720 x 130	10,2 / 400V	180	4.340,00
	99050150047	E6351D (Tek Katlı)	6 Pizza	1110 x 1260 x 420	720 x 1080 x 130	7,8 / 400V	125	2.685,00
	99050150067	E6352D (Çift Katlı)	6+6 Pizza	1110 x 1260 x 750	720 x 1080 x 130	15,6 / 400V	225	4.560,00
	99050150048	E6351W (Tek Katlı)	6 Pizza	1470 x 900 x 420	1080 x 720 x 130	10,0 / 400V	130	3.155,00
	99050150046	E6352W (Çift Katlı)	6+6 Pizza	1470 x 900 x 750	1080 x 720 x 130	20,0 / 400V	230	5.435,00

ELEKTRİKLİ BASIC MODEL PİZZA FIRINLARI
PIZZA OVENS WITH ELECTRICAL BASIC MODEL

KOD Code	MODEL	KAPASİTE Capacity	DIŞ EBAT EXT. DIM. (mm)	İÇ EBAT INT.DIM (mm)	GÜÇ Power (Kw)	AĞIRLIK Weight (kg)	FİYAT PRICE €
99050150054	E4331AB	33 cm Ø x 4	960 x 870 x 405	675 x 700 x 150	5,5 / 400V 1N	75	1.620,00
99050150043	E4332AB	33 cm Ø x 4+4	960 x 870 x 765	675 x 700 x 150	11,0 / 400V 1N	140	2.905,00
99050150053	E4301AB	30 cm Ø x 4	900 x 810 x 405	615 x 635 x 150	5,2 / 400V 3N	65	1.390,00
99050150052	E4302AB	30 cm Ø x 4+4	900 x 810 x 765	615 x 635 x 150	10,4 / 400V 3N	121	2.660,00
99050150055	E6301WAB	30 cm Ø x 6	1210 x 810 x 405	925 x 635 x 150	6 / 400V 3N	86	1.885,00
99050150042	E6302WAB	30 cm Ø x 6+6	1210 x 830 x 765	925 x 635 x 150	12 / 380V 3N	162	3.145,00

GAZLI PİZZA FIRINI
PIZZA OVEN WITH GAS

KOD Code	MODEL	KAPASİTE Capacity	DIŞ EBAT EXT. DIM. (mm)	İÇ EBAT INT.DIM (mm)	GÜÇ Power (Kw)	AĞIRLIK Weight (kg)	FİYAT PRICE €
99050150028	G4352	35 cm Ø x 4 + 4	1117 x 1017 x 790	720 x 720 x 150	19Kw	200	4.235,00

ALÜMİNYUM PİZZA KÜREĞİ
ALUMINIUM PIZZA PEEL

KOD Code	EBAT Dimension (cm)	FİYAT PRICE €
99020070002	Ø30	100,00
99020070003	Ø33	115,00
99020070004	Ø37	132,00
99020070005	Ø40	155,00
99020070006	Ø45	175,00
99020070007	Ø50	200,00



PİLİÇ ÇEVİRME MAKİNESİ
CHICKEN GRILL MACHINE



KOD Code	MODEL Model	KAPASİTE Capacity	EBAT Size (mm)	GÜÇ Power (kW)	AĞIRLIK Weight (kg)	FİYAT PRICE €
99050320001	CRG-2	8 - 10 PİLİÇ / CHICKEN	1190 x 472 x 605	9,00	65	2.380,00
99050320002	CRG-3	12 - 15 PİLİÇ / CHICKEN	1190 x 472 x 793	14,10	85	2.645,00
99050320003	CRG-4	16 - 20 PİLİÇ / CHICKEN	1190 x 472 x 981	18,80	100	3.025,00
99050320004	CRG-5	20 - 25 PİLİÇ / CHICKEN	1190 x 472 x 1169	23,00	140	3.865,00
99050320005	CRG-6	24 - 30 PİLİÇ / CHICKEN	1190 x 472 x 1357	28,20	160	4.410,00
99050320006	CRG-7	28 - 35 PİLİÇ / CHICKEN	1190 x 472 x 1545	32,90	180	4.985,00
99050320007	CRG-8	32 - 40 PİLİÇ / CHICKEN	1190 x 472 x 1733	37,00	200	5.495,00

- TR** - LPG VEYA D.gaz ile çalışır
- Emniyet ventili gaz musluklu
- Paslanmaz çelik gövde ve şiş
- 2 / 3 / 4 / 5 / 6 / 7 / 8 radyanlı ısıtıcı
- Hijyenik, emniyetli
- Sekurit ısı camlı
- Motorlu şiş döndürme

- EN** - Works with natural gas or lpg
- Safety ventile and gas facut
- Stainless steel body and skewer
- Radiant or pipe type burner
- 2 / 3 / 4 / 5 / 6 / 7 / 8 radiant burner
- Hygienic, safe, securit gas
- Skewer tuning mechanism

CRB PİLİÇ ÇEVİRME MAKİNASI DAVLUMBAZ
CHICKEN GRILL MACHINE HOOD

KOD Code	MODEL Model	EBAT Size (mm)	FİYAT PRICE €
99050320301	CRD	515 x 1145 x 170	170,00



PİLİÇ ÇEVİRME MAKİNESİ
CHICKEN GRILL MACHINE



KOD Code	MODEL Model	KAPASİTE Capacity	EBAT Size (mm)	GÜÇ Power (kW)	AĞIRLIK Weight (kg)	FİYAT PRICE €
99050320101	CRE-2	8 - 10 PİLİÇ / CHICKEN	1190 x 472 x 605	6,0	60	2.440,00
99050320102	CRE-3	12 - 15 PİLİÇ / CHICKEN	1190 x 472 x 793	9,0	80	2.890,00
99050320103	CRE-4	16 - 20 PİLİÇ / CHICKEN	1190 x 472 x 981	12,0	95	3.265,00
99050320104	CRE-5	20 - 25 PİLİÇ / CHICKEN	1190 x 472 x 1344	15,0	135	4.100,00
99050320105	CRE-6	24 - 30 PİLİÇ / CHICKEN	1190 x 472 x 1532	18,0	155	4.740,00

- TR** - Elektrikle çalışır
- Emniyet ventili gaz musluklu
- Paslanmaz çelik gövde ve şiş
- 2 / 3 / 4 / 5 / 6 / 7 / 8 radyanlı ısıtıcı
- Hijyenik, emniyetli
- Sekurit ısı camlı
- Motorlu şiş döndürme

- EN** - Works with Electricity
- Safety ventile and gas facut
- Stainless steel body and skewer
- Radiant or pipe type burner
- 2 / 3 / 4 / 5 / 6 / 7 / 8 radiant burner
- Hygienic, safe, securit gas
- Skewer tuning mechanism

CRB PİLİÇ ÇEVİRME MAKİNASI BAZA
CHICKEN GRILL MACHINE CABINET

KOD Code	MODEL Model	EBAT Size (mm)	FİYAT PRICE €
99050320201	CRB	472 x 1100 x 170	170,00
99050320202	CRM5	472 x 1100 x 545	685,00
99050320203	CRM7	472 x 1100 x 740	765,00

- * CRB model dolapsız
* CRM modek dolaplıdır



Not

Fastfood Pişiriciler

Fastfood Cookers



www.kayalarmutfak.com.tr

444 5 957





- Doğalgaz veya LPG
- Emniyet ventilli gaz valfli
- Ayarlanabilir döner şişi
- Hijyenik emniyeti ve uzun ömürlü
- Propan or natural gas
- With safety valve
- Adjustable sword (skewer)
- Hygenic, safe and long lasting

GAZLI DÖNER OCAĞI ALTAN MOTORLU GAS DONER KEBAB GRILL BOTTOM MOTOR

KOD Code	MODEL Model	EBAT Size (mm)	AĞIRLIK Weight (kg)	GERİLİM Voltage	KAPASİTE Capacity (kg)	TÜKETİM Consumption (m3/h)	GÜÇ Power (kW)	FİYAT PRICE €
99050110050	KLG - 150 / 3	550 x 715 x 900	35	230V/50Hz	20-40	1,016	9,00	1.320,00
99050110051	KLG - 151 / 4	550 x 715 x 1065	40	230V/50Hz	40-60	1,355	13,00	1.440,00
99050110052	KLG - 152 / 5	550 x 715 x 1230	45	230V/50Hz	60-80	1,694	16,00	1.600,00
99050110053	KLG - 156 / 6	550 x 715 x 1395	50	230V/50Hz	80-100	2,053	19,00	1.750,00



GAZLI DÖNER OCAĞI MOTORSUZ GAS DONER KEBAB GRILL WITHOUT MOTOR

KOD Code	MODEL Model	EBAT Size (mm)	AĞIRLIK Weight (kg)	GERİLİM Voltage	KAPASİTE Capacity (kg)	TÜKETİM Consumption (m3/h)	GÜÇ Power (kW)	FİYAT PRICE €
99050110001	KLG-140 / 3	550 x 670 x 750	22	230V/50Hz	20-40	1,016	9,00	820,00
99050110002	KLG-141 / 4	550 x 670 x 910	27	230V/50Hz	40-60	1,355	13,00	965,00
99050110003	KLG-142 / 5	550 x 670 x 1075	32	230V/50Hz	60-80	1,694	16,00	1010,00
99050110004	KLG-146 / 6	550 x 670 x 1240	37	230V/50Hz	80-100	3,053	19,00	1.250,00



- Doğalgaz veya LPG
- Emniyet ventilli gaz valfli
- Gövde hareketi (Isıtıcılar döner etine yaklaşır)
- Ayarlanabilir döner şişi
- Hijyenik emniyeti ve uzun ömürlü
- Propan or natural gas
- With safety valve
- Moving body (Zoom the burners to doner meat)
- Adjustable sword (skewer)
- Hygenic, safe and long lasting

GAZLI CAMLI DÖNER OCAĞI ALTAN MOTORLU

DONER GRILL WITH GLASS AND BOTTOM MOTOR, GAS

KOD Code	MODEL Model	EBAT Size (mm)	AĞIRLIK Weight (kg)	GERİLİM Voltage	KAPASİTE Capacity (kg)	TÜKETİM Consumption (m3/h)	GÜÇ Power (kW)	FİYAT PRICE €
99050110150	KLG 203 - G / 3	550 x 715 x 900	35	230V/50Hz	20-40	1,016	9,00	1.780,00
99050110151	KLG 204 - G / 4	550 x 715 x 1065	40	230V/50Hz	40-60	1,355	13,00	1.970,00
99050110152	KLG 205 - G / 5	550 x 715 x 1230	45	230V/50Hz	60-80	1,694	16,00	2.170,00



GAZLI CAMLI DÖNER OCAĞI MOTORSUZ DONER GRILL WITH GLASS, GAS

KOD Code	MODEL Model	EBAT Size (mm)	AĞIRLIK Weight (kg)	GERİLİM Voltage	KAPASİTE Capacity (kg)	TÜKETİM Consumption (m3/h)	GÜÇ Power (kW)	FİYAT PRICE €
99050110100	KLG 200 - G / 3	550 x 670 x 750	22	230V/50Hz	20-40	1,016	9,00	1.250,00
99050110101	KLG 201 - G / 4	550 x 670 x 910	27	230V/50Hz	40-60	1,355	13,00	1.460,00
99050110102	KLG 202 - G / 5	550 x 670 x 1075	32	230V/50Hz	60-80	1,694	16,00	1.600,00

- TR** • Doğalgaz veya LPG
• Emniyet ventilli gaz valfii
• Gövde hareketi (Isıtıcılar döner etine yaklaşır)
• Ayarlanabilir döner şişi
• Hijyenik emniyeti ve uzun ömürlü

- EN** • Propan or natural gas
• With safety valve
• Moving body (Zoom the burners to doner meat)
• Adjustable sword (skewer)
• Hygenic, safe and long lasting



GAZLI DÖNER OCAĞI ÜSTTEN MOTORLU DONER GRILL WITH TOP MOTOR,GAS

KOD Code	MODEL Model	EBAT Size (mm)	AĞIRLIK Weight (kg)	GERİLİM Voltage	KAPASİTE Capacity (kg)	TÜKETİM Consumption (m3/h)	GÜÇ Power (kW)	FİYAT PRICE €
99050110200	KLG - 220 / 3	550 x 715 x 960	25	400V/50Hz	20-40	1,016	5,00	1.045,00
99050110201	KLG - 221 / 4	550 x 715 x 1120	30	400V/50Hz	40-60	1,355	7,20	1.185,00
99050110202	KLG - 222 / 5	550 x 715 x 1285	35	400V/50Hz	60-80	1,694	9,00	1.335,00

- TR** • ROBAX Color S termal camlı
• Düşük ve yüksek, iki kademeli pişirme sıcaklığı
• Ayarlanabilir döner şişi
• Hijyenik emniyeti ve uzun ömürlü

- EN** • ROBAX Color S termal glass
• Four different level cooking temperature from low to high
• Adjustable sword (skewer)
• Hygenic, safe and long lasting



ELEKTRİKLİ DÖNER OCAĞI ÜSTTEN MOTORLU DONER GRILL WITH TOP MOTOR, ELECTRICAL

KOD Code	MODEL Model	EBAT Size (mm)	AĞIRLIK Weight (kg)	GERİLİM Voltage	KAPASİTE Capacity (kg)	GÜÇ Power (kW)	FİYAT PRICE €
99050110250	KLG - 230 / 3	550 x 715 x 960	25	400V/50Hz	20-40	5,00	1.600,00
99050110251	KLG - 231 / 4	550 x 715 x 1120	30	400V/50Hz	40-60	7,20	1.765,00
99050110252	KLG - 232 / 5	550 x 715 x 1285	35	400V/50Hz	60-80	9,00	2.035,00

- TR** • ROBAX Color S termal camlı
• Düşük ve yüksek, iki kademeli pişirme sıcaklığı
• Ayarlanabilir döner şişi
• Hijyenik emniyeti ve uzun ömürlü

- EN** • ROBAX Color S termal glass
• Four different level cooking temperature from low to high
• Adjustable sword (skewer)
• Hygenic, safe and long lasting



ELEKTRİKLİ CAMLI DÖNER OCAĞI ALTAN MOTORLU

DONER GRILL WITH GLASS AND BOTTOM MOTOR, ELECTRICAL

KOD Code	MODEL Model	EBAT Size (mm)	AĞIRLIK Weight (kg)	GERİLİM Voltage	KAPASİTE Capacity (kg)	GÜÇ Power (kW)	FİYAT PRICE €
99050110300	KLG-170 / 3	550 x 715 x 900	35	400V/50Hz	20-40	5,00	1.465,00
99050110301	KLG-171 / 4	550 x 715 x 1065	40	400V/50Hz	40-60	7,20	1.660,00
99050110302	KLG-172 / 5	550 x 715 x 1230	45	400V/50Hz	60-80	9,00	1.865,00

- TR** • Doğalgaz veya Propan (LPG) ile çalışır.
• Hijyenik ve el değmeden kesim imkanı sunar.
• Otomatik hareket mekanizması.
• Alttan motorlu (Çift yönde dönebilme özelliği)
• Düşük enerji tüketimi sağlar.
• Paslanmaz çelik gövdeli.
• Dijital kontrol paneli kolayca kullanılabilir.
• Silindirik veya konik kesim özelliği.
• Robot üzerinde et dizilebilir (ilave aparatlar ile).
• Lazer teknolojisini kullanarak hassas ölçüm yapar.
• Uzaktan erişim desteği (internet bağlantısı temin edilirse).

- EN** • Natural Gas & LPG.
• Provides hygienic and touch-free slicing.
• Automatic moving mechanism.
• Bottom motor. (Reversible in both directions)
• Low energy consumption.
• Stainless steel body.
• Digital control panel.
• Cylindrical or conical cutting feature.
• Meat can be stacked on the robot (with additional apparatus).
• Precise measurement by using laser technology.
• Remote Access support (if internet connection is provided).



GAZLI / ELEKTRİKLİ DÖNER ROBOTU DONER ROBOT, GAS / ELECTRICAL

KOD Code	MODEL Model	RADYAN Burner	EBAT Size (mm)	AĞIRLIK Weight (kg)	GERİLİM Voltage	KAPASİTE Capacity (kg)	TÜKETİM Consumption (m3/h)	GÜÇ Power (kW)	FİYAT PRICE €
	RODO4G	4	750 x 800 x 1220	80	230V/50Hz	80	1,355	13,00	18.750,00
	RODO5G	5	750 x 800 x 1400	100	230V/50Hz	100	1,694	16,25	19.150,00
	RODO4E	4	825 x 800 x 1220	68	230V/50Hz	80	-	7,2	19.400,00
	RODO5E	5	825 x 800 x 1400	73	230V/50Hz	100	-	9,0	19.800,00



- TR** * Doğalgaz veya Propan(LPG),
* Emniyet vetilli gaz valfi
* Alttan Motorlu (Çift Yönde dönebilme özelliği)
* Gövde hareketli (Isıtıcılar Döner etine yaklaşır)
* Ayarlanabilir döner şişi, Paslanmaz Çelik Gövdeli
* AISI-310S Cr-Ni Radyan Koruma Teli
- EN** * Propan or Natural Gas(LPG)
* With safety valve
* Motor at bottom (Reversible Motor)
* Moving Body (Zoom burners to doner meat)
* Adjustable Sword (Skewer)
* Stainless steel body,
* AISI-310 S Cr-Ni Burner Cover

GAZLI DÖNER OCAĞI ALTTAN MOTORLU V MODEL GAS DONER KEBAB GRILL BOTTOM MOTOR V SHAPE

KOD Code	MODEL Model	EBAT Size (mm)	AĞIRLIK Weight (kg)	GERİLİM Voltage	KAPASİTE Capacity (kg)	TÜKETİM Consumption (m3/h)	GÜÇ Power (kW)	FİYAT PRICE €
99050110400	KLG - 223-V	550 x 715 x 1065	50	230V/50Hz	50-70	2,033	19,00	1.960,00
99050110401	KLG - 224-V	750 x 800 x 1065	64	230V/50Hz	60-90	2,710	26,00	2.640,00
99050110402	KLG - 225-V	750 x 800 x 1230	71	230V/50Hz	90-120	3,388	32,00	2.880,00
99050110403	KLG - 226-V	750 x 800 x 1390	78	230V/50Hz	120-150	4,066	39,00	3.115,00



- TR** * Doğalgaz veya Propan(LPG),
* Emniyet vetilli gaz valfi
* Gövde hareketli (Isıtıcılar Döner etine yaklaşır)
* Ayarlanabilir döner şişi, Paslanmaz Çelik Gövdeli
* AISI-310S Cr-Ni Radyan Koruma Teli
- EN** * Propan or Natural Gas(LPG)
* With safety valve
* Moving Body (Zoom burners to doner meat)
* Adjustable Sword (Skewer)
* Stainless steel body,
* AISI-310 S Cr-Ni Burner Cover

GAZLI DÖNER OCAĞI MOTORSUZ V MODEL GAS DONER KEBAB GRILL V SHAPE

KOD Code	MODEL Model	EBAT Size (mm)	AĞIRLIK Weight (kg)	KAPASİTE Capacity (kg)	TÜKETİM Consumption (m3/h)	GÜÇ Power (kW)	FİYAT PRICE €
99050110450	KLG - 141-V	750 x 875 x 920	50	50-70	2,033	19,00	1.705,00
99050110451	KLG - 142-V	900 x 965 x 920	45	60-90	2,710	26,00	1.960,00
99050110452	KLG - 143-V	900 x 965 x 1085	50	90-120	3,388	32,00	1.450,00
99050110453	KLG - 146-V	900 x 110 x 1375	55	120-150	4,066	39,00	2.210,00



- TR** * Doğalgaz veya Propan(LPG),
* Emniyet vetilli gaz valfi
* Alttan Motorlu (Çift Yönde dönebilme özelliği)
* Gövde hareketli (Isıtıcılar Döner etine yaklaşır)
* Ayarlanabilir döner şişi, Paslanmaz Çelik Gövdeli
* AISI-310S Cr-Ni Radyan Koruma Teli
- EN** * Propan or Natural Gas(LPG)
* With safety valve
* Motor at bottom (Reversible Motor)
* Moving Body (Zoom burners to doner meat)
* Adjustable Sword (Skewer)
* Stainless steel body,
* AISI-310 S Cr-Ni Burner Cover

GAZLI DÖNER OCAĞI ALTTAN MOTORLU ARABALI GAS DONER KEBAB GRILL WITH BOTTOM MOTOR & TROLLEY

KOD Code	MODEL Model	EBAT Size (mm)	AĞIRLIK Weight (kg)	GERİLİM Voltage	KAPASİTE Capacity (kg)	TÜKETİM Consumption (m3/h)	GÜÇ Power (kW)	FİYAT PRICE €
99050110500	KLG - 225-VA 5+5	750 x 850 x 1840	80	230V/50Hz	200-300	3,38	32,00	6.835,00
99050110502	KLG - 226-VA 6+6	750 x 850 x 2000	80	230V/50Hz	200-400	4,66	39,00	7.130,00



ELEKTRİK DÖNER BİÇAĞI ELECTRICAL DONER KNIFE

KOD Code	BİÇAĞ EBAT Knife Size (mm)	DEVİR D/dk	FİYAT PRICE €
99050110900	Ø100	5000	1.250,00



DÖNER OCAĞI KÜREĞİ DONER GRILL SHOVEL

KOD Code	ÇAP Diameter (cm)	TİP Type	PRICE €
99060040011	26	INOX	85,00



TEKLİ TOST MAKİNESİ SINGLE COVER CONTACT GRILL

KOD Code	MODEL Model	EBAT Size (mm)	AĞIRLIK Weight (kg)	GERİLİM Voltage	DÖKÜM GENİŞLİK Plate Width (mm)	DÖKÜM DERİNLİK Plate Depth (mm)	GÜÇ Power (kW)	FİYAT PRICE €
99050440010	RN-101A	410 x 410 x 205	29	230V/50Hz	380	280	2,00	375,00
99050440011	RN-101B	410 x 410 x 205	29	230V/50Hz	380	280	2,00	375,00
99050440012	RN-101C	410 x 410 x 205	29	230V/50Hz	380	280	2,00	375,00

- TR** * Paslanmaz çelik gövdeli, hijyenik, ızgara olarak da kullanılabilen çok amaçlı ürünlerdir.
* 101A Oluklu
* 101B Alt Düz
* 101C Alt / Üst Düz

- EN** * It is a hygienic product with its stainless steel body and multipurpose products that can also be used as grill.
* 101A Ribbed
* 101B Smooth Bottom Plate
* 101C Smooth Bottom / Top Plate



BLOK KAPAK TOST MAKİNESİ BLOCK COVER CONTACT GRILL

KOD Code	MODEL Model	EBAT Size (mm)	AĞIRLIK Weight (kg)	GERİLİM Voltage	DÖKÜM GENİŞLİK Plate Width (mm)	DÖKÜM DERİNLİK Plate Depth (mm)	GÜÇ Power (kW)	FİYAT PRICE €
99050440013	RN-102	545 x 410 x 205	36	230V/50Hz	520	280	2,50	535,00

- TR** * Paslanmaz çelik gövdeli, hijyenik, ızgara olarak da kullanılabilen çok amaçlı ürünlerdir.

- EN** * It is a hygienic product with its stainless steel body and multipurpose products that can also be used as grill



ÇİFT KAPAKLI TOST MAKİNESİ DOUBLE COVER CONTACT GRILL

KOD Code	MODEL Model	EBAT Size (mm)	AĞIRLIK Weight (kg)	GERİLİM Voltage	DÖKÜM GENİŞLİK Plate Width (mm)	DÖKÜM DERİNLİK Plate Depth (mm)	GÜÇ Power (kW)	FİYAT PRICE €
99050440014	RN-103A	545 x 410 x 205	37	230V/50Hz	ALT - 520 ÜST - 220+220	ALT - 280 ÜST - 260	3,20	565,00
99050440015	RN-103B	545 x 410 x 205	37	230V/50Hz	ALT - 520 ÜST - 220+220	ALT - 280 ÜST - 260	3,20	565,00

- TR** * Paslanmaz çelik gövdeli, hijyenik, ızgara olarak da kullanılabilen çok amaçlı ürünlerdir.

- EN** * It is a hygienic product with its stainless steel body and multipurpose products that can also be used as grill



KONVEYÖRLÜ EKMEK KIZARTMA MAKİNESİ CONVEYOR TOASTER

KOD Code	MODEL Model	EBAT Size (mm)	AĞIRLIK Weight (kg)	GERİLİM Voltage	GÜÇ Power (kW)	FİYAT PRICE €
99050120005	RN-125	460 x 600 x 410	25	230V/50Hz	3,85	935,00

- TR** * Orta ve yüksek derecede kızartma
* Üst raf sayesinde ekmekler kolayca servis edilebilir
* Kapasite; 300-400 dilim/saat

- EN** * Medium and high degrees
* The upper shelf helps to serve the bread easily
* Capacity; 300-400 piece/hour



ASANSÖRLÜ SALAMANDER IZGARA ELEVATOR TYPE SALAMANDER ELECTRIC

KOD Code	MODEL Model	EBAT Size (mm)	AĞIRLIK Weight (kg)	GERİLİM Voltage	GÜÇ Power (kW)	FİYAT PRICE €
99050100009	KLK-300-45	450 x 535 x 535	33	230V/50Hz	3,0	895,00
99050100010	KLK-300-60	600 x 535 x 535	49	230V/50Hz	4,0	990,00

- TR** * Yukarı ve aşağı yönde ayarlanabilir hareketi ısıtıcı
* Hijyenik, emniyeti ve uzun ömürlü
* Ayarlanabilir tepsi ve ızgara

- EN** * Height adjustable heating element
* Hygienic, soft and long lasting
* With drip collecting tray and grid



GAZLI SALAMANDER IZGARA SALAMANDER WITH GAS

KOD Code	MODEL Model	EBAT Size (mm)	AĞIRLIK Weight (kg)	GAZ TÜKETİMİ GAS CONSUMPTION	GÜÇ Power (kW)	FİYAT PRICE €
99050100011	KLK-302	650 x 480 x 560	39	0,68m ³ /h	6,00	990,00
99050100012	KLK-303	810 x 480 x 560	43	1,02 m ³ /h	9,00	1.210,00
99050100013	KLK-304	970 x 480 x 560	47	1,35 m ³ /h	13,00	1.370,00
99050100014	KLK-306	1290 x 480 x 560	55	2,03 m ³ /h	19,00	1.685,00



ELEKTRİKLİ SALAMANDER IZGARA SALAMANDER WITH ELECTRICITY

KOD Code	MODEL Model	EBAT Size (mm)	AĞIRLIK Weight (kg)	GERİLİM Voltage	GÜÇ Power (kW)	FİYAT PRICE €
99050100015	KLK-303E	970 x 550 x 560	47	400V	6,00	1.250,00
99050100016	KLK-305E	1290 x 550 x 560	47	400V	10,00	1.540,00

Not

Soğutma Üniteleri

Cold Units



www.kayalarmutfak.com.tr

444 5 957



60 mm izolasyonlu duvarlar

Insulation Polyurethane, 60mm

Düşük Enerji tüketimi için Low Energy Consumption



Ergonomik kapı tasarımı

Ergonomic Door Design

Comfortable and changeable door



Kolay uygulanabilir kilit aparatı

Easy applicable lock set

Kolay montaj



Maksimum soğutma verimi

Maximum cooling performance

Yuvarlatılmış Köşeler



DİKEY TİP BUZDOLAP (Fanlı)

UPRIGHT REFRIGERATORS (with Fan)

KOD Code	EBAT Size (mm)	PAKET ÖLÇÜSÜ Package Dimen.. (mm)	ÇALIŞMA ISI ARALIĞI C° Work Temp	KAPASİTE Capacity	GÜÇ Power	VOLTAJ Voltage	FİYAT PRICE €
208720001000	700 x 830 x 2050	750 x 885 x 2125	+2/+8 C°	604 Lt.	0,3 kW	220 V	1.650,00
208720011000	700 x 830 x 2050	750 x 885 x 2125	+2/+8 C°	604 Lt.	0,3 kW	220 V	1.700,00
208420012000	1400 x 830 x 2050	1450 x 885 x 2125	+2/+8 C°	1334 Lt.	0,5 kW	220 V	2.400,00
208421122000	1400 x 830 x 2050	1450 x 885 x 2125	+2/+8 C°	1334 Lt.	0,5 kW	220 V	2.500,00
208720001100	700 x 830 x 2050	750 x 885 x 2125	-18/-22 C°	604 Lt.	0,5 kW	220 V	2.200,00
208720011100	700 x 830 x 2050	750 x 885 x 2125	-18/-22 C°	604 Lt.	0,5 kW	220 V	2.400,00
208420012100	1400 x 830 x 2050	1450 x 885 x 2125	-18/-22 C°	1334 Lt.	0,7 kW	220 V	3.000,00
208421122100	1400 x 830 x 2050	1450 x 885 x 2125	-18/-22 C°	1334 Lt.	0,7 kW	220 V	3.200,00



DİKEY TİP BUZDOLAP CAM KAPILI

UPRIGHT REFRIGERATORS GLASS DOOR

KOD Code	EBAT Size (mm)	PAKET ÖLÇÜSÜ Package Dimen.. (mm)	ÇALIŞMA ISI ARALIĞI C° Work Temp	KAPASİTE Capacity	GÜÇ Power	VOLTAJ Voltage	FİYAT PRICE €
208720008000	700 x 830 x 2050	750 x 885 x 2125	+2/+8 C°	604 Lt.	0,3 kW	220 V	2.000,00
208420088000	1400 x 830 x 2050	1450 x 885 x 2125	+2/+8 C°	1334 Lt.	0,5 kW	220 V	2.700,00
208720008100	700 x 830 x 2050	750 x 885 x 2125	-18/-22 C°	604 Lt.	0,5 kW	220 V	2.500,00
208420088100	1400 x 830 x 2050	1450 x 885 x 2125	-18/-22 C°	1334 Lt.	0,7 kW	220 V	3.300,00



DİKEY TİP BUZDOLAP (Statik)

UPRIGHT REFRIGERATORS (Static)

KOD Code	EBAT Size (mm)	PAKET ÖLÇÜSÜ Package Dimen.. (mm)	ÇALIŞMA ISI ARALIĞI C° Work Temp	KAPASİTE Capacity	GÜÇ Power (kW)	VOLTAJ Voltage	FİYAT PRICE €
208720001300	700 x 830 x 2050	750 x 885 x 2125	+2/+8 C°	604 Lt.	0,3	220 V	2.000,00

DİKEY TİP BUZDOLAP PASTA KİTLİ

UPRIGHT REFRIGERATORS WITH PASTRY KİT

KOD Code	EBAT Size (mm)	PAKET ÖLÇÜSÜ Package Dimen.. (mm)	ÇALIŞMA ISI ARALIĞI C° Work Temp	KAPASİTE Capacity	GÜÇ Power (kW)	VOLTAJ Voltage	FİYAT PRICE €
208720001500	700 x 830 x 2050	750 x 885 x 2125	+2/+8 C°	604 Lt.	0,3	220 V	1.750,00
208420012500	1400 x 830 x 2050	1450 x 885 x 2125	+2/+8 C°	1334 Lt.	0,5	220 V	2.450,00
208720001600	700 x 830 x 2050	750 x 885 x 2125	-18/-22 C°	604 Lt.	0,3	220 V	2.400,00
208420012600	1400 x 830 x 2050	1450 x 885 x 2125	-18/-22 C°	1334 Lt.	0,5	220 V	3.300,00

60 mm izolasyonlu duvarlar Insulation Polyurethane,60mm

Düşük Enerji tüketimi için Low Energy Consumption



Ergonomik kapı tasarımı Ergonomic Door Design

Comfortable and changeable door



Kolay uygulanabilir kilit aparatı Easy applicable lock set

Kolay montaj



Maksimum soğutma verimi Maximum cooling performance

Yuvarlatılmış Köşeler



* Çevre dostu soğutucu gaz R-134 A kullanıyoruz.

* NEGATİF BUZDOLAPLARIMIZDA (DERİN DONDURUCULARDA) çevre dostu soğutucu gaz R-404 A kullanıyoruz.

* TÜM BUZDOLABI VE DERİN DONDURUCU MODELLERİMİZ dış kapalı ortam sıcaklığının 43° C dereceye ulaşabildiği tropikal iklim koşullarında çalışmaya uygundur.

* We use ozone friendly cooling gas R-134 A in our POSITIVE REFRIGERATORS.

* We use ozone friendly cooling gas R-404 A in our NEGATIVE REFRIGERATORS (DEEP FREEZERS).

* OUR ALL REFRIGERATOR AND DEEP FREEZER MODELS are suitable to operate in outer closed environment until 43° C degree in tropical climate conditions



TEZGAH TİPİ BUZDOLAP

COUNTER TYPE REFRIGERATORS

KOD Code	ÇALIŞMA ARALIĞI Work Temp	KAPASİTE Capacity (Lt.)	GÜÇ Power (kW)	VOLTAJ Voltage	EBAT Size (mm)	PAKET ÖLÇÜSÜ Package Dimen. (mm)	FİYAT PRICE €
206480011010	+2, +8°C	234	0,30	230V 1+N 50/60Hz	1400x600x850	1450x650x980	1.600,00
206880111010	+2, +8°C	281	0,39	230V 1+N 50/60Hz	1886x600x850	1936x650x980	1.750,00
206281111010	+2, +8°C	360	0,44	230V 1+N 50/60Hz	2372x600x850	2422x650x980	2.000,00
207480011010	+2, +8°C	234	0,30	230V 1+N 50/60Hz	1400x700x850	1450x750x980	1.650,00
207880111010	+2, +8°C	281	0,39	230V 1+N 50/60Hz	1886x700x850	1936x750x980	1.800,00
207281111010	+2, +8°C	360	0,44	230V 1+N 50/60Hz	2372x700x850	2422x750x980	2.150,00
206480011110	0, -18°C	234	0,50	230V 1+N - 50/60Hz	1400x600x850	1450x650x980	1.900,00
206880111110	0, -18°C	281	0,60	230V 1+N - 50/60Hz	1886x600x850	1936x650x980	2.200,00
207480011110	0, -18°C	234	0,60	230V 1+N - 50/60Hz	1400x700x850	1450x750x980	2.000,00
207880111110	0, -18°C	281	0,60	230V 1+N - 50/60Hz	1886x700x850	1936x750x980	2.300,00



TEZGAH TİPİ BUZDOLAP CAM KAPILI
COUNTER TYPE REFRIGERATORS GLASS DOOR

KOD Code	ÇALIŞMA ARALIĞI Work Temp	KAPASİTE Capacity (Lt.)	GÜÇ Power (kW)	VOLTAJ Voltage	EBAT Size (mm)	PAKET ÖLÇÜSÜ Package Dimen.. (mm)	FİYAT PRICE €
206480088010	+2, +8°C	234	0,31	230V 1+N 50/60Hz	1400 x 600 x 850	1450 x 650 x 980	1.750,00
206880888010	+2, +8°C	281	0,41	230V 1+N 50/60Hz	1886 x 600 x 850	1936 x 650 x 980	2.000,00
206288888010	+2, +8°C	360	0,47	230V 1+N 50/60Hz	2372 x 600 x 850	2422 x 650 x 980	2.500,00
207480088010	+2, +8°C	234	0,31	230V 1+N 50/60Hz	1400 x 700 x 850	1450 x 750 x 980	1.800,00
207880888010	+2, +8°C	281	0,41	230V 1+N 50/60Hz	1886 x 700 x 850	1936 x 750 x 980	2.050,00
207288888010	+2, +8°C	360	0,47	230V 1+N 50/60Hz	2372 x 700 x 850	2422 x 750 x 980	2.750,00

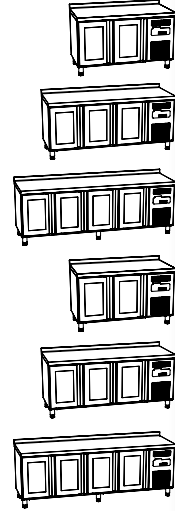

SET ALTI BUZDOLAP
UNDER COUNTER REFRIGERATORS

KOD Code	ÇALIŞMA ARALIĞI Work Temp	KAPASİTE Capacity (Lt.)	GÜÇ Power (kW)	VOLTAJ Voltage	EBAT Size (mm)	PAKET ÖLÇÜSÜ Package Dimen.. (mm)	FİYAT PRICE €
207460077010	+2, +8°C	175	0,26	230V 1+N 50/60Hz	1400 x 700 x 575	1450 x 750 x 770	1.800,00
207860777010	+2, +8°C	260	0,30	230V 1+N 50/60Hz	1886 x 700 x 575	1936 x 750 x 770	2.100,00
207267777010	+2, +8°C	340	0,35	230V 1+N 50/60Hz	2372 x 700 x 575	2422 x 750 x 770	2.500,00

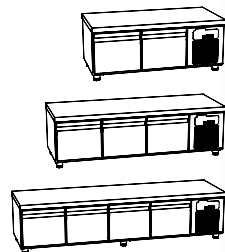

TEZGAH TİPİ BUZDOLAP ÇEKMECELİ
COUNTER TYPE REFRIGERATORS WITH DRAWERS

KOD Code	ÇALIŞMA ARALIĞI Work Temp C°	ÇEKMECE SAYISI Number Of DRAWER	KAPASİTE Capacity (Lt.)	GÜÇ Power (kW)	VOLTAJ Voltage	EBAT Size (mm)	PAKET ÖLÇÜSÜ Package Dimen. (mm)	FİYAT PRICE €
206480055010	+2, +8°C	4	234	0,30	230V 1+N 50/60Hz	1400 x 600 x 850	1450x650x980	2.000,00
206880555010	+2, +8°C	6	281	0,39	230V 1+N 50/60Hz	1886 x 600 x 850	1936x650x980	2.300,00
206285555010	+2, +8°C	8	360	0,44	230V 1+N 50/60Hz	2372 x 600 x 850	2422x650x980	2.850,00
207480055010	+2, +8°C	4	234	0,30	230V 1+N 50/60Hz	1400 x 700 x 850	1450x750x980	2.100,00
207880555010	+2, +8°C	6	281	0,39	230V 1+N 50/60Hz	1886 x 700 x 850	1936x750x980	2.400,00
207285555010	+2, +8°C	8	360	0,44	230V 1+N 50/60Hz	2372 x 700 x 850	2422x750x980	3.150,00
206480053110	0, -18°C	2	234	0,30	230V 1+N 50/60Hz	1400 x 600 x 850	1450x650x980	2.250,00
206880553110	0, -18°C	4	281	0,39	230V 1+N 50/60Hz	1886 x 600 x 850	1936x650x980	2.470,00
207480053110	0, -18°C	2	234	0,30	230V 1+N 50/60Hz	1400 x 700 x 850	1450x750x980	2.350,00
207880553110	0, -18°C	4	281	0,39	230V 1+N 50/60Hz	1886 x 700 x 850	1936x750x980	2.600,00

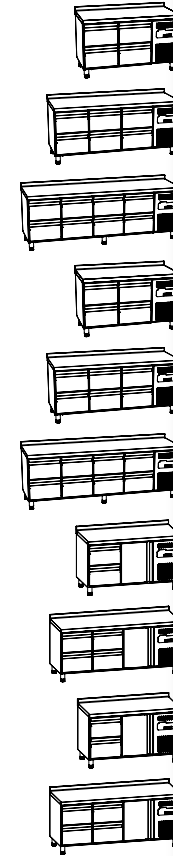



PİZZA & SALATA HAZIRLIK BUZDOLAP

PIZZA & SALAD PREPARATION REFRIGERATOR

KOD Code	ÇALIŞMA ARALIĞI Work Temp C°	KAPASİTE Capacity (Lt.)	GÜÇ Power (kW)	VOLTAJ Voltage	EBAT Size (mm)	PAKET ÖLÇÜSÜ Package Dimen. (mm)	FİYAT PRICE €
207480011810	+2, +8°C	234	0,59	230V 1+N - 50/60Hz	1400 x 700 x 850 / 1350	1450 x 750 x 1435	2.200,00
207880111810	+2, +8°C	281	0,59	230V 1+N - 50/60Hz	1886 x 700 x 850 / 1350	1900 x 750 x 1435	2.400,00



PİZZA & SALATA HAZIRLIK BUZDOLAP GRANİT TABLALI

PIZZA & SALAD PREPARATION REFRIGERATOR W.GRANITE TOP

KOD Code	ÇALIŞMA ARALIĞI Work Temp C°	KAPASİTE Capacity (Lt.)	GÜÇ Power (kW)	VOLTAJ Voltage	EBAT Size (mm)	PAKET ÖLÇÜSÜ Package Dimen.. (mm)	FİYAT PRICE €
207480011840	+2, +8°C	234	0,59	230V 1+N - 50/60Hz	1400 x 700 x 850 / 1350	1450 x 750 x 1435	2.600,00
207880111840	+2, +8°C	281	0,59	230V 1+N - 50/60Hz	1886 x 700 x 850 / 1350	1936 x 750 x 1435	3.000,00



HAMUR HAZIRLIK BUZDOLAP GRANİT TABLALI

DOUGH PREPARITION REFRIGERATOR WITH GRANITE TOP

KOD Code	ÇALIŞMA ARALIĞI Work Temp C°	KAPASİTE Capacity (Lt.)	GÜÇ Power (kW)	VOLTAJ Voltage	EBAT Size (mm)	PAKET ÖLÇÜSÜ Package Dimen. (mm)	FİYAT PRICE €
207480011040	+2, +8°C	234	0,30	230V 1+N - 50/60Hz	1400 x 700 x 850 / 1090	1450 x 750 x 1150	2.200,00
207880111040	+2, +8°C	281	0,39	230V 1+N - 50/60Hz	1886 x 700 x 850 / 1090	1936 x 750 x 1150	2.400,00
207281111040	+2, +8°C	360	0,44	230V 1+N - 50/60Hz	2372 x 700 x 850 / 1090	2422 x 750 x 1150	2.700,00

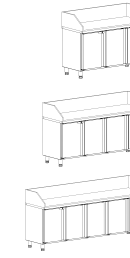

SET ÜSTÜ SALAT BAR

COUNTER TOP SALAD BAR

KOD Code	ÇALIŞMA ARALIĞI Work Temp C°	KAPASİTE Capacity (Lt.)	GÜÇ Power (kW)	VOLTAJ Voltage	EBAT Size (mm)	PAKET ÖLÇÜSÜ Package Dimen.. (mm)	FİYAT PRICE €
99050390026	+2, +8°C	234	0,20	230V 1+N - 50/60Hz	1400 x 350 x 450	1450 x 400 x 500	1.350,00
99050390025	+2, +8°C	281	0,20	230V 1+N - 50/60Hz	1886 x 350 x 450	1900 x 400 x 500	1.550,00

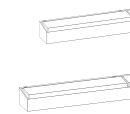



PİZZA & SALATA HAZIRLIK BUZDOLAP GRANİT TABLALI (40X60)
PIZZA & SALAD PREPARATION REFRIGERATOR W.GRANITE TOP (40X60)

KOD Code	ÇALIŞMA ARALIĞI Work Temp C°	GÜÇ Power (kW)	VOLTAJ Voltage	EBAT Size (mm)	PAKET ÖLÇÜSÜ Package Dimen.. (mm)	FİYAT PRICE €
*	+2, +8°C	0,59	230V 1+N - 50/60Hz	1550x800x1350	1600x850x1400	3.000,00
	+2, +8°C	0,59	230V 1+N - 50/60Hz	2100x800x1350	2150x850x1400	3.600,00
	+2, +8°C	0,70	230V 1+N - 50/60Hz	2650x800x1350	2700x850x1400	4.100,00

* BU MODELDE NÖTR ÇEKMECE BULUNMAMAKTADIR. / * THIS PRODUCT DOES NOT HAVE A NEUTRAL DRAWER.



TEZGAH TİPİ BUZDOLAP (40X60) STATİK
COUNTER TYPE REFRIGERATORS (40X60) STATIC

KOD Code	ÇALIŞMA ARALIĞI Work Temp	KAPASİTE Capacity (Lt.)	GÜÇ Power (kW)	VOLTAJ Voltage	EBAT Size (mm)	PAKET ÖLÇÜSÜ Package Dimen. (mm)	FİYAT PRICE €
	+2, +8°C	234	0,30	230V 1+N 50/60Hz	1550x800x850	1600x850x900	2.400,00
	+2, +8°C	281	0,39	230V 1+N 50/60Hz	2100x800x850	2150x850x900	2.900,00
	+2, +8°C	281	0,50	230V 1+N 50/60Hz	2650x800x850	2700x850x900	3.400,00



TEZGAH TİPİ BUZDOLAP (40X60) COUNTER TYPE REFRIGERATORS (40X60)

KOD Code	ÇALIŞMA ARALIĞI Work Temp	KAPASİTE Capacity (Lt.)	GÜÇ Power (kW)	VOLTAJ Voltage	EBAT Size (mm)	PAKET ÖLÇÜSÜ Package Dimen. (mm)	FİYAT PRICE €
	+2, +8°C	234	0,30	230V 1+N 50/60Hz	1550x800x850	1600x850x900	2.700,00
	+2, +8°C	281	0,39	230V 1+N 50/60Hz	2100x800x850	2150x850x900	3.200,00
	+2, +8°C	360	0,44	230V 1+N 50/60Hz	2650x800x850	2700x850x900	3.700,00

KOD Code	AÇIKLAMA DESCRIPTION	FİYAT PRICE (€)
10040910002	Refrigerator Door Switch	5,00
YM003000004	GN 1/1 (3x1/3) Drawer Group	390,00
YM003000003	GN 1/1 (2x1/2) Drawer Group	310,00
YM003000002	YP Counter Type Standard Door	120,00
YM003000102	YP Counter Type Glass Door	150,00
YM003000003	Under Counter Standard Door	360,00
DM003000001	Upright Standard Door	300,00
DM003000101	Upright Standard Glass Door	(-2/+8 C°) 300,00 € (-18/-22C°) 550,00€
DM011000001	Lock Set	40,00
D0010110066	Pastry Kit Slide	20,00

KOD Code	AÇIKLAMA DESCRIPTION	FİYAT PRICE (€)
10030510020	2 Wheels Kit Set With Brake	65,00
10030510021	2 Wheels Kit Set Without Brake	65,00
DM126000002	Cooling Group DP-820	600,00
DM126000001	Cooling Group DP-810	600,00
YM126000005	Cooling Group YP - 673	600,00
YM126000006	Cooling Group YP - 674	900,00
YM126000001	Cooling Group YP - 672	600,00
10030520101	YP 600 Stainless Steel Wire Shelf	9,00
10030520100	DP Stainless Steel Wire Shelf	11,00
10030520102	YP 700 Stainless Steel Wire Shelf	9,00
10020210103	Refrigerator Door Seal DP	40,00
10020210100	Refrigerator Door Seal YPS	25,00
10020210105	Refrigerator Door Seal YP	30,00
10040110100	Digital Indicator With Single Probe	100,00
10040110101	Digital Indicator With Double Probe	110,00



PORTATİF SOĞUK HAVA DEPOLARI GENEL ÖZELLİKLERİ

- Hafiftir, dayanıklıdır ve montaj kolaylığı sağlar.
- Hazırlanmış olan soğuk hava depolarında et, süt ve diğer tüm gıda maddelerinin en iyi ve en uzun süre muhafaza edilmesini sağlar.
- Elektro statik boyalı saclar RAL 9002 kullanılmaktadır.
- Panel kalınlıklarımız taze muhafaza odalarda 80 mm, donmuş muhafazalarda 120 mm olarak imal edilmektedir.
- Panellerimiz yan yana, birbirine geçmeli, kilitli sistemden oluşturulmaktadır.
- Teknik ekipmanlarla teknik ekip tarafından kurulumu sağlanmaktadır.
- Gaz: 404 A

SOĞUK ODA KAPISI GENEL ÖZELLİKLERİ

- Kapı iç ve dış yüzeyleri elektro statik boyalı saclar RAL 9002 saçtan mamul olup içi 42 kg/m3 dansitede poliüretan enjeksiyon ile izolasyonludur.
- Kapı kolları kilitlenebilir tip içerden ve dışardan açılabilen emniyet mekanizmalıdır.
- İzolasyon kalınlığı soğuk odalarda 80 mm, donmuş muhafazalarda 120 mm olarak imal edilmektedir.
- Gaz:404 A

STYROFOAM/DOW GENEL ÖZELLİKLERİ

- Mükemmel ve sürekli ısı yalıtım özelliği
- Suya karşı mükemmel direnç ve sıfır kapilerite
- Dona karşı dayanım
- Yüksek ve uzun süreli basma mukavemeti
- Yüksek elastik modülü
- Kullanım yerine uygun optimum su buharı difüzyon direnci
- Gaz: 404 A

AKSESUARLAR

- Köşebent alüminyum
- Köşe plastiği
- Armatür
- Soğuk oda kapı menteşesi
- Soğuk oda kapı kilidi

PORTABLE COLD STORAGES GENERAL FEATURES

- It is light, durable and provides montage facility.
- It provides the best and the longest time storage of meat, milk, vegetable and all other food in the cold storages which are prepared.
- RAL 9002 is used with the electrostatic painted sheet metals.
- The thickness of the panel is manufactured as 80 mm with the fresh keeping rooms and 120 mm and 150 mm with the frozen storage rooms.
- Our panels are consisted of the side-by-side, dovetailed to each other and locking system.
- Its installation is made by the technical team using technical equipment.
- Gas: 404 A

COLD ROOM DOOR GENERAL FEATURES

- The interior and exterior surfaces of the door are made of RAL 9002 electrostatic painted sheet metals and the inside is insulated with 42 kg/m3 density polyurethane injection.
- The door handles are of lockable-type with a safety mechanism that can be opened from inside and outside.
- The insulation thickness is made as 80 mm in the cold rooms and 120 mm and 150 mm in the frozen storages.
- Gas:404 A

STYROFOAM/DOW GENERAL FEATURES

- Perfect and continual heat insulation feature
- Perfect resistance against water and zero capillarity
- Resistance against freezing
- High and long term pressing resistance
- High elastic module
- Optimum water vapor diffusion resistance suitable to the site to be used.
- Gas:404 A

ACCESSORY

- Corner piece aluminum
- Corner plastic
- Armature
- Cold room door hinge
- Cold room door lock



SOĞUK ODA DEPOSU (0°C / +2°C)
COLD ROOM (0°C / +2°C)

KOD Code	MODEL Model	ÜRÜN ADI Product Name	EBAT Size (mm)	AĞIRLIK Weight (kg)	NET (m³)	GÜÇ Power (kW)	ELEKTRİK GÜCÜ Electrical Power (kW)	SOĞUTMA KAPASİTESİ Cooling Capacity (kW)
99050380002	KYLR.SD.10	Soğuk Oda Paneli+Tavan+Taban+Kapı	2000 x 2000 x 2300	295	2.77			
99050380002	KYLR.SG.10	Soğuk Oda Soğutma Grubu	SD.10 Grubu For SD.10	55	0.18	1.5	1.62	3.86
99050380002	KYLR.SD.30	Soğuk Oda Paneli+Tavan+Taban+Kapı	2400 x 2400 x 2300	415	3.1			
99050380002	KYLR.SG.30	Soğuk Oda Soğutma Grubu	SD.30 Grubu For SD.30	62	0.25	2	2.2	5.03
99050380002	KYLR.SD.50	Soğuk Oda Paneli+Tavan+Taban+Kapı	2400 x 3600 x 2300	545	3.7			
99050380002	KYLR.SG.50	Soğuk Oda Soğutma Grubu	SD.50 Grubu For SD.50	85	0.45	2.5	2.33	5.68
99050380002	KYLR.SD.70	Soğuk Oda Paneli+Tavan+Taban+Kapı	4000 x 4000 x 2300	722	6			
99050380002	KYLR.SG.70	Soğuk Oda Soğutma Grubu	SD.70 Grubu For SD.70	97	0.5	3	2.33	6.30
99050380002	KYLR.SD.90	Soğuk Oda Paneli+Tavan+Taban+Kapı	5000 x 4000 x 2300	888	7.37			
99050380002	KYLR.SG.90	Soğuk Oda Soğutma Grubu	SD.90 Grubu For SD.90	114	1.16	3	3.02	7.26
99050380002	KYLR.SD.110	Soğuk Oda Paneli+Tavan+Taban+Kapı	5000 x 5000 x 2300	1099	10.69			
99050380002	KYLR.SG.110	Soğuk Oda Soğutma Grubu	SD.110 Grubu For SD.110	129	1.5	4	4.01	9.01

ÜRÜNLERİMİZ İÇİN LÜTFEN FİYAT ALINIZ. / TAKE QUOTATION FOR OUR PRODUCTS.

SİPARİŞLER KOD İLE DEĞİL ÜRÜN AÇIKLAMASI İLE YAPILACAKTIR.



SOĞUK ODA DEPOSU (-18°C)
COLD ROOM (-18°C)

KOD Code	MODEL Model	ÜRÜN ADI Product Name	EBAT Size (mm)	AĞIRLIK Weight (kg)	NET (m³)	GÜÇ Power (kW)	ELEKTRİK GÜCÜ Electrical Power (kW)	SOĞUTMA KAPASİTESİ Cooling Capacity (kW)
99050380001	KYLR.SD.20	Soğuk Oda Paneli+Tavan+Taban+Kapı	2000 x 2000 x 2300	295	2.77			
99050380001	KYLR.SG.20	Soğuk Oda Soğutma Grubu	SD.20 Grubu For SD.20	55	0.18	1.5	1.22	1.6
99050380001	KYLR.SD.40	Soğuk Oda Paneli+Tavan+Taban+Kapı	2400 x 2400 x 2300	415	3.1			
99050380001	KYLR.SG.40	Soğuk Oda Soğutma Grubu	SD.40 Grubu For SD.40	62	0.25	2	1.55	2.18
99050380001	KYLR.SD.60	Soğuk Oda Paneli+Tavan+Taban+Kapı	2400 x 3600 x 2300	545	3.7			
99050380001	KYLR.SG.60	Soğuk Oda Soğutma Grubu	SD.60 Grubu For SD.60	85	0.45	3	2.5	3.13
99050380001	KYLR.SD.80	Soğuk Oda Paneli+Tavan+Taban+Kapı	4000 x 4000 x 2300	722	6			
99050380001	KYLR.SG.80	Soğuk Oda Soğutma Grubu	SD.80 Grubu For SD.80	97	0.5	3	4.13	4.35
99050380001	KYLR.SD.100	Soğuk Oda Paneli+Tavan+Taban+Kapı	5000 x 4000 x 2300	888	7.37			
99050380001	KYLR.SG.100	Soğuk Oda Soğutma Grubu	SD.100 Grubu For SD.100	114	1.16	7	5.62	4.7
99050380001	KYLR.SD.120	Soğuk Oda Paneli+Tavan+Taban+Kapı	5000 x 5000 x 2300	1099	10.69			
99050380001	KYLR.SG.120	Soğuk Oda Soğutma Grubu	SD.120 Grubu For SD.120	129	1.5	5	4.13	5.52

ÜRÜNLERİMİZ İÇİN LÜTFEN FİYAT ALINIZ. / TAKE QUOTATION FOR OUR PRODUCTS.

SİPARİŞLER KOD İLE DEĞİL ÜRÜN AÇIKLAMASI İLE YAPILACAKTIR.



Bulaşık Yıkama Ekipmanları

Diswasher Equipments



2 VE 3 KAPILI ŞİŞE SOĞUTUCULAR BOTTLE COOLERS

KOD Code	MODEL	KAPASİTE Capacity (Lt.)	GÜÇ Power (W)	EBAT Size (mm)	FİYAT PRICE €
99050390029	LG-208H Çarpma 2 Kapı Double Hinged Doors	156	260W	920 x 520 x 900	1.700,00
99050390030	LG-208S Sürgülü 2 Kapı Double Sliding Doors	156	260W	920 x 520 x 900	1.800,00
99050390031	LG-330H Çarpma 3 Kapı Triple Hinged Doors	240	330W	1350 x 520 x 900	2.000,00
99050390032	LG-330S Sürgülü 3 Kapı Triple Sliding Doors	240	330W	1350 x 520 x 900	2.100,00

- TR** * PVC kaplı sac iç ve dış gövde.
* CFC içermeyen, yüksek basınçla enjekte edilmiş, 30 mm kalınlığında poliüretan izolasyon.
* Özel tasarım rolbond evaporatör.
* Kilitlenebilir cam kapılar.
* Aydınlatmalı iç kabin.
* Ayarlanabilir iç raflar.
* Fanlı soğutma sistemi.

- EN** * Interior and exterior PVC coated.
* CFC free, high pressure injection polyurethane insulation in 30 mm thickness.
* Custom design rolbond evaporator.
* Lockable glass doors.
* Interior illumination.
* Adjustable shelf unit.
* Ventilated refrigeration system.



www.kayalarmutfak.com.tr

444 5 957





- TR** * Makinenin gövdesi ve su ile temasta bulunan bütün kısımlar paslanmaz çelik saçtan üretilmiştir.
 * Yıkamanın sonlandığını gösteren sesli uyarı sistemi bulunmaktadır.
 * Hata ve arıza kodları cihaz kontrol panelinden görülebilmektedir.
 * Kapak açıldığında çalışmayı durduracak emniyet sistemi bulunmaktadır.
 * Makine, maksimum 290 mm yüksekliğindeki bardakları ve diğer nesnelere yıkama özelliğine sahiptir.
 * Yıkama ve durulama kolları ile filtreler temizlik için kolayca sökülüp takılabilir yapıdadır.
 * Cihazda standart aksesuar olarak; 400*400 mm ölçülerinde 1 adet bardak kasası bulunmaktadır.
 * İsteğe bağlı opsiyonel üniteler: Durulama Pompası, Boşaltma Pompası, Deterjan Pompası.

- EN** * All parts; which are in the body of the machine and the water; are produced stainless steel plate.
 * There is an audio alarm system indicating that washing has ended.
 * Error and fault Codes can be seen from the device control panel.
 * When the door is opened; there is a safety system to stop the operation.
 * The machine can wash glasses and other objects at a maximum height of 290 mm.
 * Washing and rinsing arms and filters can be easily disassembled for cleaning.
 * As a standard accessory; there is 1 glass rack with 400*400 mm dimensions
 * Optional units: Rinsing pump, draining pump, detergent pump.

BARDAK YIKAMA MAKİNASI GLASSWARE DISHWASHER

KOD Code	MODEL Type	DIŞ EBAT External Size (mm)	BASKET EBAT Basket Size (mm)	GÜÇ Power (kW)	AĞIRLIK Weight (kg)	SU GİRİŞ BASINCI Inlet Water Pressure (Kpa)	VOLTAJ Voltage (V)	KAPASİTE (Bardak/saat) Capacity (Glass/hour)	FİYAT PRICE €
99050030012	400-B	450 x 510 x 650	350 x 350 x 150	3,3	39	200-400	220 V, 1N, 50Hz	400-700	1.750,00



- TR** * Makinenin gövdesi ve su ile temasta bulunan bütün kısımlar paslanmaz çelik saçtan üretilmiştir.
 * Yıkamanın sonlandığını gösteren sesli uyarı sistemi bulunmaktadır.
 * Hata ve arıza kodları cihaz kontrol panelinden görülebilmektedir.
 * Kapak açıldığında çalışmayı durduracak emniyet sistemi bulunmaktadır.
 * Makine, maksimum 290 mm yüksekliğindeki bardakları ve diğer nesnelere yıkama özelliğine sahiptir.
 * Yıkama ve durulama kolları ile filtreler temizlik için kolayca sökülüp takılabilir yapıdadır.
 * Cihazda standart aksesuar olarak; 400*400 mm ölçülerinde 1 adet bardak kasası bulunmaktadır.
 * İsteğe bağlı opsiyonel üniteler: Durulama Pompası, Boşaltma Pompası, Deterjan Pompası.

- EN** * All parts; which are in the body of the machine and the water; are produced stainless steel plate.
 * There is an audio alarm system indicating that washing has ended.
 * Error and fault Codes can be seen from the device control panel.
 * When the door is opened; there is a safety system to stop the operation.
 * The machine can wash glasses and other objects at a maximum height of 290 mm.
 * Washing and rinsing arms and filters can be easily disassembled for cleaning.
 * As a standard accessory; there is 1 glass rack with 400*400 mm dimensions
 * Optional units: Rinsing pump, draining pump, detergent pump.

500 TABAK YIKAMA MAKİNASI 500 PLATES DISHWASHER

KOD Code	MODEL Type	DIŞ EBAT External Size (mm)	BASKET EBAT Basket Size (mm)	GÜÇ Power (kW)	AĞIRLIK Weight (kg)	SU GİRİŞ BASINCI Inlet Water Pressure (Kpa)	VOLTAJ Voltage (V)	KAPASİTE (Tabak/saat) Capacity (Plate/hour)	FİYAT PRICE €
99050030008	500-T	600 x 650 x 800	500 x 500 x 100	6,00	60	200-400	220 V, 1N, 50Hz	500	2.000,00



- TR** - Paslanmaz çelik gövde ve şase
 - Yüksek kalitede paslanmaz çelik ısıtıcılar
 - Dönen Yıkama Kolları
 - Kapağın kapatılmasıyla başlayan yıkama döngüsü
 - Otomatik dolan yıkama tankı
 - Emniyet termostatu
 - Kullanıcı dostu kumanda arayüzü
 - Yüksekliği ayarlanabilir ayaklar
 - Drenaj ve durulama pompası bağlanabilme imkanı

- EN** - Stainless Steel construction
 - All Heaters are manufactured with high quality stainless steel.
 - Rotating washing arms
 - Four type washing program
 - Automatic tank loading
 - Safety thermostat inside
 - User - friendly command interface
 - Height adjustable feet
 - Drain and pressure pump can be connected to chassis

1000 TABAK GİYOTİN TİP BULAŞIK YIKAMA MAKİNASI 1000 PLATE DISHWASHER MACHINE

KOD Code	MODEL Type	DIŞ EBAT External Size (mm)	BASKET EBAT Basket Size (mm)	GÜÇ Power (kW)	AĞIRLIK Weight (kg)	SU GİRİŞ BASINCI Inlet Water Pressure (Kpa)	VOLTAJ Voltage (V)	KAPASİTE (Tabak/saat) Capacity (Plate/hour)	FİYAT PRICE €
99050030002	1000-T	650 x 800 x 1360/1800	500 x 500 x 100	9,00	95	200-400	380 V, 3N, 50Hz	1000	2.600,00



- TR** - Paslanmaz çelik gövde ve şase
 - Modern ve şık dizayn
 - Manyetik kapı siviçi
 - Yüksek kalitede paslanmaz çelik ısıtıcılar
 - Kapağın kapatılmasıyla başlayan yıkama işlemi
 - Dijital sıcaklık göstergeleri
 - Bağımsız ön yıkama ve yıkama tankı
 - Ön ısıtmalı boiler tank sistemi
 - Çift hız kademeli konveyör sistem
 - Emniyet termostatları
 - Kullanıcı dostu kumanda arayüzü
 - Yüksekliği ayarlanabilir ayaklar
 - Drenaj ve durulama pompası bağlanabilme imkanı
 - Güvenlik için acil durdurma butonu

- EN** - Stainless Steel construction
 - Modern and stylish design
 - Magnetic door switch
 - High quality stainless steel heaters
 - Cycle start at door closing
 - Digital temperature display
 - Individual pre-wash and wash tank
 - Pre-heated boiler tank system
 - Conveyor system with dual-stage speed
 - Safety switches
 - User friendly control interface
 - Height adjustable legs
 - Possibility of attaching the drain and rinse pump
 - Emergency stop button for safety

KURUTMA ÜNİTELİ BULAŞIK MAKİNASI CONVEYOR TYPE DISHWASHER MACHINE

Kod Code	Model	Ebat Size (mm)	Güç Power (kW)	Ağırlık Weight (kg)	Voltaj Voltage (V)	Kapasite Capacity (Kaset/saat) (Rack / h)	Kapasite Capacity (Tabak/saat) (Plate / hour)	FİYAT PRICE €
99050030004	2000-T	2535 x 815 x 1800	43,5	255	380 V, 3N, 50Hz	120	2000	9.000,00
99050030005	3000-T	3050 x 800 x 1800	49,5	295	380 V, 3N, 50Hz	170	2700	11.520,00
99050030007	3000-TKD	3850 x 800 x 2020	34,5	340	380 V, 3N, 50Hz	200	3600	13.780,00

- * BYM-220-L/R - Ön Kurutmasız
 * BYM-270-L/R - Ön Kurutmalı ve Durulmalı
 * BYM-360 - Ön Kurutmalı ve 2 Durulmalı

- Kurutma Tüneli
 BYK-K70 70cm - 3.200 €
 BYK-K90 90cm - 3.850 €



BULAŞIK MAKİNESİ GİRİŞ - ÇIKIŞ TEZGAHLI
DISHWASHER MACHINE WITH INLET /OUTLET TABLES

KOD Code	MODEL Type	EBAT TEZGAH Table Size (mm)	EBAT EVYE Sink Size (mm)	FİYAT PRICE €
40110868002122	Giriş Tek Evye Sol	1000 x 750 x 850	400 x 500 x 250	525,00
40114868002122	Giriş Tek Evye Sol	1400 x 750 x 850	400 x 500 x 250	570,00
40116868002122	Giriş Tek Evye Sol	1600 x 750 x 850	400 x 500 x 250	700,00
40110868001122	Giriş Tek Evye Sağ	1000 x 750 x 850	400 x 500 x 250	525,00
40114868001122	Giriş Tek Evye Sağ	1400 x 750 x 850	400 x 500 x 250	570,00
40116868001122	Giriş Tek Evye Sağ	1600 x 750 x 850	400 x 500 x 250	700,00
40114868002322	Giriş Çift Evye Sol	1400 x 750 x 850	400 x 500 x 250	730,00
40116868002322	Giriş Çift Evye Sol	1600 x 750 x 850	400 x 500 x 250	800,00
40118868002322	Giriş Çift Evye Sol	1800 x 750 x 850	400 x 500 x 250	870,00
40114868001322	Giriş Çift Evye Sağ	1400 x 750 x 850	400 x 500 x 250	730,00
40116868001322	Giriş Çift Evye Sağ	1600 x 750 x 850	400 x 500 x 250	800,00
40118868001322	Giriş Çift Evye Sağ	1800 x 750 x 850	400 x 500 x 250	870,00
40108871002000	Çıkış Tezgahı Sol	800 x 750 x 850	400 x 500 x 250	330,00
40110871002000	Çıkış Tezgahı Sol	1000 x 750 x 850	400 x 500 x 250	360,00
40112871002000	Çıkış Tezgahı Sol	1200 x 750 x 850	400 x 500 x 250	400,00
40108871001000	Çıkış Tezgahı Sağ	800 x 750 x 850	400 x 500 x 250	330,00
40110871001000	Çıkış Tezgahı Sağ	1000 x 750 x 850	400 x 500 x 250	360,00
40112871001000	Çıkış Tezgahı Sağ	1200 x 750 x 850	400 x 500 x 250	400,00



9 BÖLMELİ BARDAK BASKETİ / EXTENDER GLASS BASKET - 9

KOD Code	BÖLÜM SAYISI Compartment	DIŞ EBAT External Size (cm)	BÖLME EBATİ Div. Sizes	BÖLME YÜKSEKLİĞİ Div. Height	FİYAT PRICE €
99080010031	9 - 0	50,1 x 50,1 x 10,1	15 x 15	8,00	19,00



16 BÖLMELİ BARDAK BASKETİ / EXTENDER GLASS BASKET - 16

KOD Code	BÖLÜM SAYISI Compartment	DIŞ EBAT External Size (cm)	BÖLME EBATİ Div. Sizes	BÖLME YÜKSEKLİĞİ Div. Height	FİYAT PRICE €
99080010023	16 - 0	50,1 x 50,1 x 10,1	11,2 x 11,2	8,00	20,00



25 BÖLMELİ BARDAK BASKETİ / EXTENDER GLASS BASKET - 25

KOD Code	BÖLÜM SAYISI Compartment	DIŞ EBAT External Size (cm)	BÖLME EBATİ Div. Sizes	BÖLME YÜKSEKLİĞİ Div. Height	FİYAT PRICE €
99080010025	25 - 0	50,1 x 50,1 x 10,1	8,9 x 8,9	8,00	22,00



36 BÖLMELİ BARDAK BASKETİ / EXTENDER GLASS BASKET - 36

KOD Code	BÖLÜM SAYISI Compartment	DIŞ EBAT External Size (cm)	BÖLME EBATİ Div. Sizes	BÖLME YÜKSEKLİĞİ Div. Height	FİYAT PRICE €
99080010027	36 - 0	50,1 x 50,1 x 10,1	7,4 x 7,4	8,00	23,00



49 BÖLMELİ BARDAK BASKETİ / EXTENDER GLASS BASKET - 49

KOD Code	BÖLÜM SAYISI Compartment	DIŞ EBAT External Size (cm)	BÖLME EBATİ Div. Sizes	BÖLME YÜKSEKLİĞİ Div. Height	FİYAT PRICE €
99080010029	49 - 0	50,1 x 50,1 x 10,1	6,2 x 6,2	8,00	25,00



TEMEL BASKET / BASE RACK

KOD Code	DIŞ EBAT External Size (cm)	FİYAT PRICE €
99080010112	50,1 x 50,1 x 10,1	21,00



TABAK BASKETİ / PLATE RACK

KOD Code	DIŞ EBAT External Size (cm)	FİYAT PRICE €
99080010109	50,1 x 50,1 x 10,1	21,00



TEPSİ BASKETİ / TRAY RACK

KOD Code	DIŞ EBAT External Size (cm)	FİYAT PRICE €
99080010117	50,1 x 50,1 x 10,1	21,00



ÇATAL KAŞIK BASKETİ / CUTLERY RACK

KOD Code	DIŞ EBAT External Size (cm)	FİYAT PRICE €
99080010104	50,1 x 50,1 x 10,1	18,00



AÇIK YÜKSELTİCİ / EMPTY EXTENDER

KOD Code	EBAT Size (mm)	FİYAT PRICE €
99080010118	500 x 500 x 100	7,00

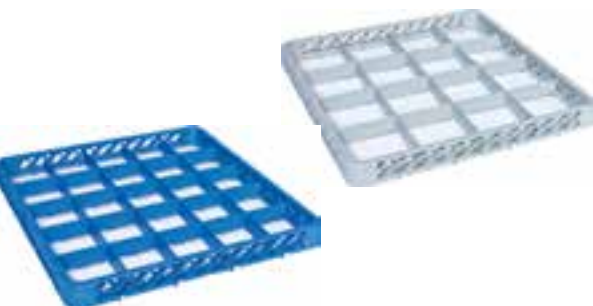

BASKET YÜKSELTİCİLERİ / EXTENDERS FOR RACKS

KOD Code	EBAT Size (mm)	BÖLÜM SAYISI Division Size	FİYAT PRICE €
99080010103	500 x 500 x 40	3 x 3	8,00
99080010096	500 x 500 x 40	4 x 4	9,00
99080010097	500 x 500 x 40	5 x 5	10,00
99080010101	500 x 500 x 40	6 x 6	11,00
99080010102	500 x 500 x 40	7 x 7	12,00



BARDAK BASKETİ / GLASS RACKS

KOD Code	EBAT Size (mm)	FİYAT PRICE €
99080010066	350 x 350 x 160	14,00

İÇ APARATLAR FİYATA DAHİL DEĞİLDİR



DİK KAŞIK BASKETİ (8 BÖLÜMLÜ) / UPRIGHT BASKET FOR CUTLERY

KOD Code	EBAT Size (mm)	FİYAT PRICE €
99080010108	430 x 210 x 155	18,00



SPREY ÜNİTESİ / SPRAY UNIT

KOD Code	KULLANIM YERİ	FİYAT PRICE €
99070020001	Duvara Monte Tipi Wall Type	230,00
99070020003	Tezgaha Monte Tipi For Work Table Top	210,00



YER YIKAMA HORTUMU / CLEANING HOSE

KOD Code	MODEL Model	EBAT Size (mt)	FİYAT PRICE €
99050030018	Yer Temizleme	10	1.300,00
99050030019	Yer Temizleme	15	1.500,00



DETERJAN / DETERGENT

KOD CODE	FİYAT PRICE €
99040010001	70,00

YER IZGARASI ORTA HİZA YANDAN ÇIKIŞLI
FLOOR GRID WITH SIDE OUTLET SIPHON IN THE MIDDLE

KOD Code	EBAT (EN x BOY) Size (Width x Length) (cm)	FİYAT PRICE €
99070050034	30 x 30	130,00
99070050035	30 x 50	170,00
99070050036	30 x 74	220,00
99070050037	30 x 94	270,00
99070050010	30 x 118	300,00
99070050011	30 x 138	350,00
99070050012	30 x 161	400,00
99070050033	30 x 185	415,00
99070050013	30 x 205	485,00
99070050017	30 x 225	520,00
99070050018	30 x 249	590,00



A : 23,5 cm x 23,5cm
B : 43,5 cm x 23,5cm

YER IZGARASI ORTA HİZA ALTTAN ÇIKIŞLI
FLOOR GRID WITH BOTTOM OUTLET SIPHON IN THE MIDDLE

KOD Code	EBAT (EN x BOY) Size (Width x Length) (cm)	FİYAT PRICE €
99070050016	30 x 30	140,00
99070050027	30 x 50	170,00
99070050028	30 x 74	230,00
99070050029	30 x 94	275,00
99070050014	30 x 118	305,00
99070050022	30 x 138	355,00
99070050023	30 x 161	405,00
99070050015	30 x 181	420,00
99070050024	30 x 205	495,00
99070050025	30 x 225	525,00
99070050026	30 x 249	595,00



A : 23,5 cm x 23,5cm
B : 43,5 cm x 23,5cm



YAĞ TUTUCU
OIL KEEPER

KOD Code	MODEL Model	KAPASİTE Capacity (Lt)	EBAT Size (mm)	FİYAT PRICE €
99070050005	KLT-20	20	310 x 650 x 340	500,00
99070050006	KLT-30	30	405 x 730 x 400	600,00
99070050007	KLT-60	60	625 x 900 x 530	800,00

Çalışma Tezgahları

Work Tables



www.kayalarmutfak.com.tr

444 5 957





ÇALIŞMA TEZGAHI TABAN RAFSIZ
WORK TABLE WITHOUT BOTTOM SHELF

KOD Code	EBAT Size (mm)			HACİM VOLUME (m ³)	FİYAT PRICE €
	L	W	H		
70610801000000	1000	600	850	0,5668	243,00
70611801000000	1100	600	850	0,6229	254,00
70612801000000	1200	600	850	0,6791	268,00
70613801000000	1300	600	850	0,7352	278,00
70614801000000	1400	600	850	0,7913	300,00
70615801000000	1500	600	850	0,8474	308,00
70616801000000	1600	600	850	0,9035	319,00
70617801000000	1700	600	850	0,9597	342,00
70618801000000	1800	600	850	1,0158	353,00
70619801000000	1900	600	850	1,0719	364,00

KOD Code	EBAT Size (mm)			HACİM VOLUME (m ³)	FİYAT PRICE €
	L	W	H		
70710801000000	1000	700	850	0,6597	257,00
70711801000000	1100	700	850	0,7250	273,00
70712801000000	1200	700	850	0,7903	289,00
70713801000000	1300	700	850	0,8556	300,00
70714801000000	1400	700	850	0,9210	316,00
70715801000000	1500	700	850	0,9863	332,00
70716801000000	1600	700	850	1,0516	342,00
70717801000000	1700	700	850	1,1169	363,00
70718801000000	1800	700	850	1,1822	380,00
70719801000000	1900	700	850	1,2476	391,00



ÇALIŞMA TEZGAHI TABAN VE ARA RAFLI
WORK TABLE WITH BOTTOM AND MIDDLE SHELF

KOD Code	EBAT Size (mm)			HACİM VOLUME (m ³)	FİYAT PRICE €
	L	W	H		
70610801200000	1000	600	850	0,5668	330,00
70611801200000	1100	600	850	0,6229	350,00
70612801200000	1200	600	850	0,6791	375,00
70613801200000	1300	600	850	0,7352	400,00
70614801200000	1400	600	850	0,7913	420,00
70615801200000	1500	600	850	0,8474	445,00
70616801200000	1600	600	850	0,9035	470,00
70617801200000	1700	600	850	0,9597	495,00
70618801200000	1800	600	850	1,0158	515,00
70619801200000	1900	600	850	1,0719	540,00

KOD Code	EBAT Size (mm)			HACİM VOLUME (m ³)	FİYAT PRICE €
	L	W	H		
70710801200000	1000	700	850	0,6597	355,00
70711801200000	1100	700	850	0,7250	385,00
70712801200000	1200	700	850	0,7903	410,00
70713801200000	1300	700	850	0,8556	435,00
70714801200000	1400	700	850	0,9210	460,00
70715801200000	1500	700	850	0,9863	485,00
70716801200000	1600	700	850	1,0516	510,00
70717801200000	1700	700	850	1,1169	540,00
70718801200000	1800	700	850	1,1822	565,00
70719801200000	1900	700	850	1,2476	590,00



ÇALIŞMA TEZGAHI TABAN RAFLI
WORK TABLE WITH BOTTOM SHELF

KOD Code	EBAT Size (mm)			HACİM VOLUME (m ³)	FİYAT PRICE €
	L	W	H		
70610801100000	1000	600	850	0,5668	273,00
70611801100000	1100	600	850	0,6229	294,00
70612801100000	1200	600	850	0,6791	310,00
70613801100000	1300	600	850	0,7352	326,00
70614801100000	1400	600	850	0,7913	348,00
70615801100000	1500	600	850	0,8474	364,00
70616801100000	1600	600	850	0,9035	385,00
70617801100000	1700	600	850	0,9597	400,00
70618801100000	1800	600	850	1,0158	417,00
70619801100000	1900	600	850	1,0719	439,00

KOD Code	EBAT Size (mm)			HACİM VOLUME (m ³)	FİYAT PRICE €
	L	W	H		
70710801100000	1000	700	850	0,6597	295,00
70711801100000	1100	700	850	0,7250	316,00
70712801100000	1200	700	850	0,7903	337,00
70713801100000	1300	700	850	0,8556	353,00
70714801100000	1400	700	850	0,9210	375,00
70715801100000	1500	700	850	0,9863	396,00
70716801100000	1600	700	850	1,0516	417,00
70717801100000	1700	700	850	1,1169	433,00
70718801100000	1800	700	850	1,1822	455,00
70719801100000	1900	700	850	1,2476	476,00



TEK ÇEKMECELİ ÇALIŞMA TEZGAHI TABAN RAFLI
WORK TABLE WITH BOTTOM SHELF AND SINGLE DRAWER

KOD Code	EBAT Size (mm)			HACİM VOLUME (m ³)	FİYAT PRICE €
	L	W	H		
70610801105000	1000	600	850	0,5668	415,00
70611801105000	1100	600	850	0,6229	430,00
70612801105000	1200	600	850	0,6791	450,00
70613801105000	1300	600	850	0,7352	465,00
70614801105000	1400	600	850	0,7913	480,00
70615801105000	1500	600	850	0,8474	495,00
70616801105000	1600	600	850	0,9035	510,00
70617801105000	1700	600	850	0,9597	530,00
70618801105000	1800	600	850	1,0158	545,00
70619801105000	1900	600	850	1,0719	560,00

KOD Code	EBAT Size (mm)			HACİM VOLUME (m ³)	FİYAT PRICE €
	L	W	H		
70710801105000	1000	700	850	0,65973	435,00
70711801105000	1100	700	850	0,7250	455,00
70712801105000	1200	700	850	0,7903	470,00
70713801105000	1300	700	850	0,8556	490,00
70714801105000	1400	700	850	0,92101	505,00
70715801105000	1500	700	850	0,9863	525,00
70716801105000	1600	700	850	1,0516	540,00
70717801105000	1700	700	850	1,1169	560,00
70718801105000	1800	700	850	1,1822	580,00
70719801105000	1900	700	850	1,2476	595,00



HAREKETLİ ÇALIŞMA TEZGAHI TABAN RAFLI
MOBILE WORK TABLE WITH BOTTOM SHELF

KOD Code	EBAT Size (mm)			HACİM VOLUME (m ³)	FİYAT PRICE €
	L	W	H		
70610800110000	1000	600	850	0,5298	385,00
70611800110000	1100	600	850	0,5823	405,00
70612800110000	1200	600	850	0,6348	430,00
70613800110000	1300	600	850	0,6872	450,00
70614800110000	1400	600	850	0,7397	470,00
70615800110000	1500	600	850	0,7921	495,00
70616800110000	1600	600	850	0,8446	515,00
70617800110000	1700	600	850	0,8971	540,00
70618800110000	1800	600	850	0,9495	560,00
70619800110000	1900	600	850	1,0020	580,00

KOD Code	EBAT Size (mm)			HACİM VOLUME (m ³)	FİYAT PRICE €
	L	W	H		
70710800110000	1000	700	850	0,6167	410,00
70711800110000	1100	700	850	0,67776	435,00
70712800110000	1200	700	850	0,7388	460,00
70713800110000	1300	700	850	0,7998	480,00
70714800110000	1400	700	850	0,8609	505,00
70715800110000	1500	700	850	0,9220	530,00
70716800110000	1600	700	850	0,9830	555,00
70717800110000	1700	700	850	1,0441	577,00
70718800110000	1800	700	850	1,1051	600,00
70719800110000	1900	700	850	1,1662	625,00



HAREKETLİ ÇALIŞMA TEZGAHI TABAN VE ARA RAFLI
MOBILE WORK TABLE WITH BOTTOM AND MIDDLE SHELF

KOD Code	EBAT Size (mm)			HACİM VOLUME (m ³)	FİYAT PRICE €
	L	W	H		
70610800210000	1000	600	850	0,5298	470,00
70611800210000	1100	600	850	0,5823	500,00
70612800210000	1200	600	850	0,6348	530,00
70613800210000	1300	600	850	0,6872	560,00
70614800210000	1400	600	850	0,7397	590,00
70615800210000	1500	600	850	0,7921	620,00
70616800210000	1600	600	850	0,8446	650,00
70617800210000	1700	600	850	0,8971	680,00
70618800210000	1800	600	850	0,9495	710,00
70619800210000	1900	600	850	1,0020	740,00

KOD Code	EBAT Size (mm)			HACİM VOLUME (m ³)	FİYAT PRICE €
	L	W	H		
70710800210000	1000	700	850	0,6167	505,00
70711800210000	1100	700	850	0,67776	540,00
70712800210000	1200	700	850	0,73882	575,00
70713800210000	1300	700	850	0,79988	605,00
70714800210000	1400	700	850	0,86094	640,00
70715800210000	1500	700	850	0,92200	670,00
70716800210000	1600	700	850	0,98306	705,00
70717800210000	1700	700	850	1,04412	740,00
70718800210000	1800	700	850	1,1051	770,00
70719800210000	1900	700	850	1,1662	805,00



DOLAPLI ÇALIŞMA TEZGAHI ÇARPMA KAPILI ARA RAFLI
WORK TABLE WITH CUPBOARD WITH MIDDLE SHELF

KOD Code	EBAT Size (mm)			HACİM VOLUME (m ³)	FİYAT PRICE €
	L	W	H		
70610801420000	1000	600	850	0,5668	596,00
70611801420000	1100	600	850	0,6229	637,00
70612801420000	1200	600	850	0,6791	675,00
70613801420000	1300	600	850	0,7352	751,00
70614801420000	1400	600	850	0,7913	759,00
70615801420000	1500	600	850	0,8474	799,00
70616801420000	1600	600	850	0,9035	840,00
70617801420000	1700	600	850	0,9597	898,00
70618801420000	1800	600	850	1,0158	930,00
70619801420000	1900	600	850	1,0719	970,00

KOD Code	EBAT Size (mm)			HACİM VOLUME (m ³)	FİYAT PRICE €
	L	W	H		
70710801420000	1000	700	850	0,6597	638,00
70711801420000	1100	700	850	0,7250	682,00
70712801420000	1200	700	850	0,7903	723,00
70713801420000	1300	700	850	0,8556	802,00
70714801420000	1400	700	850	0,9210	812,00
70715801420000	1500	700	850	0,9863	855,00
70716801420000	1600	700	850	1,0516	898,00
70717801420000	1700	700	850	1,1169	951,00
70718801420000	1800	700	850	1,1822	994,00
70719801420000	1900	700	850	1,2476	1.038,00



DOLAPLI ÇALIŞMA TEZGAHI ARA RAFLI SÜRGÜ KAPILI
WORK TABLE WITH MIDDLE SHELF SLIDING DOORS

KOD Code	EBAT Size (mm)			HACİM VOLUME (m ³)	FİYAT PRICE €
	L	W	H		
70610801320000	1000	600	850	0,5668	630,00
70611801320000	1100	600	850	0,6229	675,00
70612801320000	1200	600	850	0,6791	715,00
70613801320000	1300	600	850	0,7352	760,00
70614801320000	1400	600	850	0,7913	800,00
70615801320000	1500	600	850	0,8474	845,00
70616801320000	1600	600	850	0,9035	885,00
70617801320000	1700	600	850	0,9597	940,00
70618801320000	1800	600	850	1,0158	980,00
70619801320000	1900	600	850	1,0719	1.020,00

KOD Code	EBAT Size (mm)			HACİM VOLUME (m ³)	FİYAT PRICE €
	L	W	H		
70710801320000	1000	700	850	0,6597	635,00
70711801320000	1100	700	850	0,7250	720,00
70712801320000	1200	700	850	0,7903	765,00
70713801320000	1300	700	850	0,8556	810,00
70714801320000	1400	700	850	0,9210	855,00
70715801320000	1500	700	850	0,9863	900,00
70716801320000	1600	700	850	1,0516	945,00
70717801320000	1700	700	850	1,1169	995,00
70718801320000	1800	700	850	1,1822	1.050,00
70719801320000	1900	700	850	1,2476	1.090,00



DOLAPLI ÇALIŞMA TEZGAHI BLOK ÇEKMECELİ
WORK TABLE DRAWERS, SLIDING DOORS AND INTERMEDIATE SHELF

KOD Code	EBAT Size (mm)			HACİM VOLUME (m ³)	FİYAT PRICE €
	L	W	H		
70615801326000	1500	600	850	0,8474	1.085,00
70616801326000	1600	600	850	0,9035	1.125,00
70617801326000	1700	600	850	0,9597	1.170,00
70618801326000	1800	600	850	1,0158	1.210,00
70619801326000	1900	600	850	1,0719	1.255,00

KOD Code	EBAT Size (mm)			HACİM VOLUME (m ³)	FİYAT PRICE €
	L	W	H		
70715801326000	1500	700	850	0,9863	1.150,00
70716801326000	1600	700	850	1,0516	1.195,00
70717801326000	1700	700	850	1,1169	1.240,00
70718801326000	1800	700	850	1,1822	1.285,00
70719801326000	1900	700	850	1,2476	1.330,00



ÇALIŞMA TEZGAHI 4 ÇEKMECELİ TABAN RAFSIZ
WORK TABLE WITH 4 DRAWERS

KOD Code	EBAT Size (mm)			HACİM VOLUME (m ³)	FİYAT PRICE €
	L	W	H		
70614801006000	1400	600	850	0,7913	790,00
70615801006000	1500	600	850	0,8474	805,00
70616801006000	1600	600	850	0,9035	820,00
70617801006000	1700	600	850	0,9597	835,00
70618801006000	1800	600	850	1,0158	850,00
70619801006000	1900	600	850	1,0719	870,00

KOD Code	EBAT Size (mm)			HACİM VOLUME (m ³)	FİYAT PRICE €
	L	W	H		
70714801006000	1400	700	850	0,9210	810,00
70715801006000	1500	700	850	0,9863	850,00
70716801006000	1600	700	850	1,0516	860,00
70717801006000	1700	700	850	1,1169	880,00
70718801006000	1800	700	850	1,1822	900,00
70719801006000	1900	700	850	1,2476	920,00



ÇALIŞMA TEZGAHI 4 ÇEKMECELİ TABAN RAFLI
WORK TABLE DRAWERS, BOTTOM SHELF

KOD Code	EBAT Size (mm)			HACİM VOLUME (m ³)	FİYAT PRICE €
	L	W	H		
70614801106000	1400	600	850	0,7913	830,00
70615801106000	1500	600	850	0,8474	845,00
70616801106000	1600	600	850	0,9035	865,00
70617801106000	1700	600	850	0,9597	885,00
70618801106000	1800	600	850	1,0158	910,00
70619801106000	1900	600	850	1,0719	930,00

KOD Code	EBAT Size (mm)			HACİM VOLUME (m ³)	FİYAT PRICE €
	L	W	H		
70714801106000	1400	700	850	0,9210	875,00
70715801106000	1500	700	850	0,9863	895,00
70716801106000	1600	700	850	1,0516	915,00
70717801106000	1700	700	850	1,1169	935,00
70718801106000	1800	700	850	1,1822	965,00
70719801106000	1900	700	850	1,2476	985,00



DEPOLAMA DOLABI İKİ KAPILI 3 ARA RAFLI
PAN CUPBOARD WITH DOUBLE DOORS AND 3 INTERMEDIATE SHELVES

KOD Code	EBAT Size (mm)	FİYAT PRICE €
70612140000000	1200 x 600 x 1600	1.335,00

KOD Code	EBAT Size (mm)	FİYAT PRICE €
70712140000000	1200 x 700 x 1600	1.550,00



POLİETİLEN TABLALI ÇALIŞMA TEZGAHI TABAN RAFSIZ
PE TOP WORK TABLE WITHOUT BOTTOM SHELF

KOD Code	EBAT Size (mm)			HACİM VOLUME (m ³)	FİYAT PRICE €
	L	W	H		
70610807000000	1000	600	850	0,5668	479,00
70611807000000	1100	600	850	0,6229	508,00
70612807000000	1200	600	850	0,6791	539,00
70613807000000	1300	600	850	0,7352	574,00
70614807000000	1400	600	850	0,7913	605,00
70615807000000	1500	600	850	0,8474	635,00
70616807000000	1600	600	850	0,9035	665,00
70617807000000	1700	600	850	0,9597	702,00
70618807000000	1800	600	850	1,0158	738,00
70619807000000	1900	600	850	1,0719	768,00

KOD Code	EBAT Size (mm)			HACİM VOLUME (m ³)	FİYAT PRICE €
	L	W	H		
70710807000000	1000	700	850	0,6597	526,00
70711807000000	1100	700	850	0,7250	562,00
70712807000000	1200	700	850	0,7903	600,00
70713807000000	1300	700	850	0,8556	635,00
70714807000000	1400	700	850	0,9210	665,00
70715807000000	1500	700	850	0,9863	702,00
70716807000000	1600	700	850	1,0516	750,00
70717807000000	1700	700	850	1,1169	786,00
70718807000000	1800	700	850	1,1822	823,00
70719807000000	1900	700	850	1,2476	858,00



MERMER TABLALI ÇALIŞMA TEZGAHI TABAN RAFSIZ
MARBLE TOP WORK TABLE WITHOUT BOTTOM SHELF

KOD Code	EBAT Size (mm)			HACİM VOLUME (m ³)	FİYAT PRICE €
	L	W	H		
70610803000000	1000	600	850	0,5668	567,00
70611803000000	1100	600	850	0,6229	605,00
70612803000000	1200	600	850	0,6791	645,00
70613803000000	1300	600	850	0,7352	684,00
70614803000000	1400	600	850	0,7913	726,00
70615803000000	1500	600	850	0,8474	772,00
70616803000000	1600	600	850	0,9035	814,00
70617803000000	1700	600	850	0,9597	864,00
70618803000000	1800	600	850	1,0158	904,00
70619803000000	1900	600	850	1,0719	944,00

KOD Code	EBAT Size (mm)			HACİM VOLUME (m ³)	FİYAT PRICE €
	L	W	H		
70710803000000	1000	700	850	0,6597	612,00
70711803000000	1100	700	850	0,7250	660,00
70712803000000	1200	700	850	0,7903	705,00
70713803000000	1300	700	850	0,8556	759,00
70714803000000	1400	700	850	0,9210	804,00
70715803000000	1500	700	850	0,9863	853,00
70716803000000	1600	700	850	1,0516	904,00
70717803000000	1700	700	850	1,1169	950,00
70718803000000	1800	700	850	1,1822	998,00
70719803000000	1900	700	850	1,2476	1.053,00



POLİETİLEN TABLALI ÇALIŞMA TEZGAHI TABAN RAFLI
PE TOP WORK TABLE WITH BOTTOM SHELF

KOD Code	EBAT Size (mm)			HACİM VOLUME (m ³)	FİYAT PRICE €
	L	W	H		
70610807100000	1000	600	850	0,5668	514,00
70611807100000	1100	600	850	0,6229	550,00
70612807100000	1200	600	850	0,6791	586,00
70613807100000	1300	600	850	0,7352	622,00
70614807100000	1400	600	850	0,7913	660,00
70615807100000	1500	600	850	0,8474	702,00
70616807100000	1600	600	850	0,9035	738,00
70617807100000	1700	600	850	0,9597	781,00
70618807100000	1800	600	850	1,0158	823,00
70619807100000	1900	600	850	1,0719	858,00

KOD Code	EBAT Size (mm)			HACİM VOLUME (m ³)	FİYAT PRICE €
	L	W	H		
70710807100000	1000	700	850	0,6597	557,00
70711807100000	1100	700	850	0,7250	600,00
70712807100000	1200	700	850	0,7903	641,00
70713807100000	1300	700	850	0,8556	690,00
70714807100000	1400	700	850	0,9210	732,00
70715807100000	1500	700	850	0,9863	776,00
70716807100000	1600	700	850	1,0516	823,00
70717807100000	1700	700	850	1,1169	865,00
70718807100000	1800	700	850	1,1822	908,00
70719807100000	1900	700	850	1,2476	957,00



POLİETİLEN TABLALI ET KÜTÜĞÜ
POLYETHYLENE TOP MEAT CHOPPING TABLE

KOD Code	EBAT Size (mm)			HACİM VOLUME (m ³)	FİYAT PRICE €
	L	W	H		
70606801000000	600	600	850	0,3423	600,00

KOD Code	EBAT Size (mm)			HACİM VOLUME (m ³)	FİYAT PRICE €
	L	W	H		
70707801000000	700	700	850	0,463772	715,00



TEK EVYELİ ÇALIŞMA TEZGAHI ALT TABLASIZ
WORK TABLE WITH SINGLE SINK WITHOUT BOTTOM SHELF

KOD Code	EVYE EBATI Sink Dimens. (cm)	EBAT Size (mm)			HACİM VOLUME (m ³)	FİYAT PRICE €
		L	W	H		
70606808000112	40X40X25	600	600	850	0,3423	355,00
70607808000122	40X50X25	700	600	850	0,3984	405,00

KOD Code	EVYE EBATI Sink Dimens. (cm)	EBAT Size (mm)			HACİM VOLUME (m ³)	FİYAT PRICE €
		L	W	H		
70706808000122	40X50X25	600	700	850	0,3984	405,00
70707808000122	40X50X25	700	700	850	0,4637	440,00
70707808000223	50X50X30	700	700	850	0,4637	470,00



3 EVYELİ TEZGAH ALT TABLASIZ
SINK WITH 3 BOWLS WITHOUT BOTTOM SHELF

KOD Code	EVYE EBATI Sink Dimens. (cm)	EBAT Size (mm)			HACİM VOLUME (m ³)	FİYAT PRICE €
		L	W	H		
70618808000512	40X40X25	1800	600	850	1,016	845,00
70618808000522	40X50X25	1800	600	850	1,016	870,00
70619808000512	40X40X25	1900	600	850	1,072	955,00
70619808000522	40X50X25	1900	600	850	1,072	985,00

KOD Code	EVYE EBATI Sink Dimens. (cm)	EBAT Size (mm)			HACİM VOLUME (m ³)	FİYAT PRICE €
		L	W	H		
70718808000623	50X50X30	1800	700	850	1,182	1.045,00
70719808000623	50X50X30	1900	700	850	1,248	1.155,00



TEK EVYELİ ÇALIŞMA TEZGAHI ALT TABLASIZ
WORK TABLE WITH SINGLE SINK WITHOUT BOTTOM SHELF

KOD Code	DAMLALIK TİPİ Drip Tray Type	EVYE ADEDİ Sink Quantity	EVYE EBATI Sink Dimens. (cm)	EBAT Size (mm)			HACİM VOLUME (m ³)	FİYAT PRICE €
				L	W	H		
70610808001112	RIGHT-HAND DRIP TRAY / TEK SAĞ DAMLALIKLI	1	40X40X25	1000	600	850	0,567	460,00
70610808001122	RIGHT-HAND DRIP TRAY / TEK SAĞ DAMLALIKLI	1	40X50X25	1000	600	850	0,567	485,00
70612808001112	RIGHT-HAND DRIP TRAY / TEK SAĞ DAMLALIKLI	1	40X40X25	1200	600	850	0,679	495,00
70612808001122	RIGHT-HAND DRIP TRAY / TEK SAĞ DAMLALIKLI	1	40X50X25	1200	600	850	0,679	533,00
70614808001122	RIGHT-HAND DRIP TRAY / TEK SAĞ DAMLALIKLI	1	40X50X25	1400	600	850	0,791	575,00
70616808001122	RIGHT-HAND DRIP TRAY / TEK SAĞ DAMLALIKLI	1	40X50X25	1600	600	850	0,904	605,00
70618808001122	RIGHT-HAND DRIP TRAY / TEK SAĞ DAMLALIKLI	1	40X50X25	1800	600	850	1,016	635,00
70610808002112	LEFT-HAND DRIP TRAY / TEK SOL DAMLALIKLI	1	40X40X25	1000	600	850	0,567	460,00
70610808002122	LEFT-HAND DRIP TRAY / TEK SOL DAMLALIKLI	1	40X50X25	1000	600	850	0,567	485,00
70612808002112	LEFT-HAND DRIP TRAY / TEK SOL DAMLALIKLI	1	40X40X25	1200	600	850	0,679	495,00
70612808002122	LEFT-HAND DRIP TRAY / TEK SOL DAMLALIKLI	1	40X50X25	1200	600	850	0,679	535,00
70614808002122	LEFT-HAND DRIP TRAY / TEK SOL DAMLALIKLI	1	40X50X25	1400	600	850	0,791	575,00
70616808002122	LEFT-HAND DRIP TRAY / TEK SOL DAMLALIKLI	1	40X50X25	1600	600	850	0,904	600,00
70618808002122	LEFT-HAND DRIP TRAY / TEK SOL DAMLALIKLI	1	40X50X25	1800	600	850	1,016	640,00
70710808001122	RIGHT-HAND DRIP TRAY / TEK SAĞ DAMLALIKLI	1	40X50X25	1000	700	850	0,660	575,00
70712808001223	RIGHT-HAND DRIP TRAY / TEK SAĞ DAMLALIKLI	1	50x50x30	1200	700	850	0,850	595,00
70714808001122	RIGHT-HAND DRIP TRAY / TEK SAĞ DAMLALIKLI	1	40X50X25	1400	700	850	0,921	625,00
70716808001122	RIGHT-HAND DRIP TRAY / TEK SAĞ DAMLALIKLI	1	40X50X25	1600	700	850	1,052	650,00
70718808001223	RIGHT-HAND DRIP TRAY / TEK SAĞ DAMLALIKLI	1	50x50x30	1800	700	850	1,100	750,00
70710808002122	LEFT-HAND DRIP TRAY / TEK SOL DAMLALIKLI	1	40X50X25	1000	700	850	0,660	575,00
70712808002223	LEFT-HAND DRIP TRAY / TEK SOL DAMLALIKLI	1	50x50x30	1200	700	850	0,850	595,00
70714808002122	LEFT-HAND DRIP TRAY / TEK SOL DAMLALIKLI	1	40X50X25	1400	700	850	0,921	625,00
70716808002122	LEFT-HAND DRIP TRAY / TEK SOL DAMLALIKLI	1	40X50X25	1600	700	850	1,052	645,00
70718808002223	LEFT-HAND DRIP TRAY / TEK SOL DAMLALIKLI	1	50x50x30	1800	700	850	1,100	755,00



ÇİFT EVYELİ ÇALIŞMA TEZGAHI ALT TABLASIZ
WORK TABLE WITH DOUBLE SINK WITHOUT BOTTOM

KOD Code	DAMLALIK TİPİ Drip Tray Type	EVYE ADEDİ Sink Quantity	EVYE EBATI Sink Dimens. (cm)	EBAT Size (mm)			HACİM VOLUME (m³)	FİYAT PRICE €
				L	W	H		
70614808001312	RIGHT-HAND DRIP TRAY / SAĞ DAMLALIK	2	40X40X25	1400	600	850	0,791	577,00
70614808001322	RIGHT-HAND DRIP TRAY / SAĞ DAMLALIK	2	40X50X25	1400	600	850	0,791	610,00
70616808001312	RIGHT-HAND DRIP TRAY / SAĞ DAMLALIK	2	40X40X25	1600	600	850	0,904	630,00
70616808001322	RIGHT-HAND DRIP TRAY / SAĞ DAMLALIK	2	40X50X25	1600	600	850	0,904	660,00
70618808001322	RIGHT-HAND DRIP TRAY / SAĞ DAMLALIK	2	40X50X25	1800	600	850	1,016	685,00
70619808001322	RIGHT-HAND DRIP TRAY / SAĞ DAMLALIK	2	40X50X25	1900	600	850	1,072	715,00
70614808002312	LEFT-HAND DRIP TRAY / SOL DAMLALIK	2	40X40X25	1400	600	850	0,791	577,00
70614808002322	LEFT-HAND DRIP TRAY / SOL DAMLALIK	2	40X50X25	1400	600	850	0,791	610,00
70616808002312	LEFT-HAND DRIP TRAY / SOL DAMLALIK	2	40X40X25	1600	600	850	0,904	630,00
70616808002322	LEFT-HAND DRIP TRAY / SOL DAMLALIK	2	40X50X25	1600	600	850	0,904	660,00
70618808002322	LEFT-HAND DRIP TRAY / SOL DAMLALIK	2	40X50X25	1800	600	850	1,016	682,00
70619808002322	LEFT-HAND DRIP TRAY / SOL DAMLALIK	2	40X50X25	1900	600	850	1,072	715,00
70714808001322	RIGHT-HAND DRIP TRAY / SAĞ DAMLALIK	2	40X50X25	1400	700	850	0,921	682,00
70716808001322	RIGHT-HAND DRIP TRAY / SAĞ DAMLALIK	2	40X50X25	1600	700	850	1,052	790,00
70716808001423	RIGHT-HAND DRIP TRAY / SAĞ DAMLALIK	2	50X50X30	1600	700	850	1,052	820,00
70718808001423	RIGHT-HAND DRIP TRAY / SAĞ DAMLALIK	2	50X50X30	1800	700	850	1,182	810,00
70718808001433	RIGHT-HAND DRIP TRAY / SAĞ DAMLALIK	2	50X60X30	1800	700	850	1,182	840,00
70719808001423	RIGHT-HAND DRIP TRAY / SAĞ DAMLALIK	2	50X50X30	1900	700	850	1,248	860,00
70719808001433	RIGHT-HAND DRIP TRAY / SAĞ DAMLALIK	2	50X60X30	1900	700	850	1,248	895,00
70714808002322	LEFT-HAND DRIP TRAY / SOL DAMLALIK	2	40X50X25	1400	700	850	0,921	685,00
70716808002322	LEFT-HAND DRIP TRAY / SOL DAMLALIK	2	40X50X25	1600	700	850	1,052	790,00
70716808002423	LEFT-HAND DRIP TRAY / SOL DAMLALIK	2	50X50X30	1600	700	850	1,052	820,00
70718808002423	LEFT-HAND DRIP TRAY / SOL DAMLALIK	2	50X50X30	1800	700	850	1,182	810,00
70718808002433	LEFT-HAND DRIP TRAY / SOL DAMLALIK	2	50X60X30	1800	700	850	1,182	840,00
70719808002423	LEFT-HAND DRIP TRAY / SOL DAMLALIK	2	50X50X30	1900	700	850	1,248	860,00
70719808002433	LEFT-HAND DRIP TRAY / SOL DAMLALIK	2	50X60X30	1900	700	850	1,248	895,00



EVYELER MAT / SINK SATIN

KOD Code	EBAT / Size (cm)	FİYAT PRICE €
56001000001	40 x 40 x 25	70,00
56001000002	40 x 40 x 30	80,00
56001000003	40 x 50 x 25	74,00
56001000004	40 x 50 x 30	80,00
56001000005	50 x 50 x 25	80,00
56001000006	50 x 50 x 30	90,00
56001000007	50 x 60 x 25	95,00
56001000008	50 x 60 x 30	104,00



SOL DAMLALIKLI TEK GÖZLÜ EVYE
SINK W. SINGLE BOWL LEFT DRAINER

KOD Code	EVYE EBAT SINK Size (cm)	TABLA EBAT Size (cm)	FİYAT PRICE €
10030310176	40x40x25	100x60	198,00
10030310181	50x50x30	100x70	248,00
10030310260	40x40x25	120x60	208,00
10030310261	40x50x25	120x60	229,00
10030310263	50x50x30	120x70	254,00
10030310265	40x50x25	140x60	254,00
10030310269	50x50x30	140x70	280,00
10030310275	40x50x25	160x60	254,00
10030310279	50x50x30	160x70	297,00
10030310285	50x50x30	190x70	330,00



SAĞ DAMLALIKLI TEK GÖZLÜ EVYE
SINK W. SINGLE BOWL RIGHT DRAINER

KOD Code	EVYE EBAT SINK Size (cm)	TABLA EBAT Size (cm)	FİYAT PRICE €
10030310174	40x40x25	100x60	196,00
10030310179	50x50x30	100x70	248,00
10030310258	40x40x25	120x60	208,00
10030310259	40x50x25	120x60	229,00
10030310262	50x50x30	120x70	254,00
10030310264	40x50x25	140x60	254,00
10030310267	50x50x30	140x70	280,00
10030310274	40x50x25	160x60	254,00
10030310277	50x50x30	160x70	297,00
10030310284	50x50x30	190x70	330,00

Sipariş esnasında sağ/sol damlalık özellikleri belirtilmesi gerekmektedir.



SAĞ DAMLALIKLI ÇİFT GÖZLÜ EVYE
SINK W. DOUBLE BOWL RIGHT DRAINER

KOD Code	EVYE EBAT Size (cm)	TABLA EBAT Size (cm)	FİYAT PRICE €
10030310354	40x50x25	140 x 70	405,00
10030310362	40x40x25	160 x 60	375,00
10030310363	40x50x25	160 x 60	405,00
10030310366	40x50x25	160 x 70	425,00
10030310367	50x50x30	160 x 70	480,00
10030310370	40x50x25	180 x 60	425,00
10030310372	50x50x30	180 x 70	500,00
10030310376	40x50x25	190 x 60	435,00
10030310378	50x50x30	190 x 70	510,00

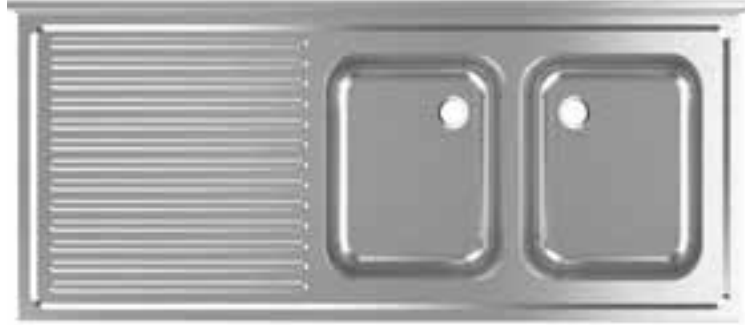

SOL DAMLALIKLI ÇİFT GÖZLÜ EVYE
SINK W. DOUBLE BOWL LEFT DRAINER

KOD Code	EVYE EBAT Size (cm)	TABLA EBAT Size (cm)	FİYAT PRICE €
10030310355	40x50x25	140 x 70	405,00
10030310364	40x40x25	160 x 60	375,00
10030310365	40x50x25	160 x 60	405,00
10030310368	40x50x25	160 x 70	425,00
10030310369	50x50x30	160 x 70	480,00
10030310371	40x50x25	180 x 60	425,00
10030310374	50x50x30	180 x 70	500,00
10030310377	40x50x25	190 x 60	435,00
10030310380	50x50x30	190 x 70	510,00



KOD Code	EBAT Size (mm)			HACİM VOLUME (m ³)	FİYAT PRICE €
	L	W	H		
40612831001000	1200	600	850	0,679	399,00
40616831001000	1600	600	850	0,904	465,00
40619831001000	1900	600	850	1,072	523,00

ÇÖP SIYIRMA TEZGAHLARI SAĞ HUNİLİ
WASTE PEELING TABLES WITH HOLE FROM RIGHT

KOD Code	EBAT Size (mm)			HACİM VOLUME (m ³)	FİYAT PRICE €
	L	W	H		
40712831001000	1200	700	850	0,790	430,00
40716831001000	1600	700	850	1,052	500,00
40719831001000	1900	700	850	1,248	560,00



KOD Code	EBAT Size (mm)			HACİM VOLUME (m ³)	FİYAT PRICE €
	L	W	H		
40612831002000	1200	600	850	0,679	399,00
40616831002000	1600	600	850	0,904	465,00
40619831002000	1900	600	850	1,072	523,00

ÇÖP SIYIRMA TEZGAHLARI SOL HUNİLİ
WASTE PEELING TABLES WITH HOLE FROM LEFT

KOD Code	EBAT Size (mm)			HACİM VOLUME (m ³)	FİYAT PRICE €
	L	W	H		
40712831002000	1200	700	850	0,790	430,00
40716831002000	1600	700	850	1,052	500,00
40719831002000	1900	700	850	1,248	560,00



SÜZME TEZGAHLARI
STRAINING TABLES

KOD Code	EBAT Size (mm)			HACİM VOLUME (m ³)	FİYAT PRICE €
	L	W	H		
70712809000003	1200	700	850	0,790	725,00
70714809000003	1400	700	850	0,921	820,00
70718809000003	1800	700	850	1,182	1.210,00



KAZAN YIKAMA TEZGAHLARI
BOILER WASHING TABLES

KOD Code	EBAT Size (mm)			FİYAT PRICE €
	L	W	H	
99130110001	1200	800	570/910	977,00
99130110002	1400	800	570/910	1.081,00



DİZDEN KUMANDALI EL YIKAMA EVYESİ ÇİFT SU GİRİŞLİ
HAND WASH SINK FROM KNEE OPERATED

KOD Code	MODEL	TİP	EBAT Size (cm)	FİYAT PRICE €
99070010001	KGD 584	DUVARA MONTE	50 x 42 x 25 / 50	420,00



DUVAR RAFI TEK SIRA
WALL SHELF SINGLE - ROW

KOD Code	EBAT Size (mm)	FİYAT PRICE €
70310021000000	1000 x 300 x 40	136,00
70312021000000	1200 x 300 x 40	152,00
70314021000000	1400 x 300 x 40	168,00
70316021000000	1600 x 300 x 40	178,00
70319021000000	1900 x 300 x 40	195,00



DUVAR DOLABI SÜRME KAPILI VE ARA RAFLI
WALL CUPBOARD WITH SLIDING DOOR AND INTERMEDIATE SHELF

KOD Code	EBAT / Size (mm)	FİYAT PRICE €
70410610000000	1000 x 400 x 600	420,00
70412610000000	1200 x 400 x 600	483,00
70415610000000	1500 x 400 x 600	572,00
70419610000000	1900 x 400 x 600	703,00



SICAKLIK DOLABI
HOT CUPBOARD

KOD Code	EBAT Size (mm)	SICAKLIK TEMP. C°	GÜÇ Power (kW)	GERİLİM Voltage	FİYAT PRICE €
70610881320000	1000 x 600 x 850	30-90	1,5	220 V	935,00
70611881320000	1100 x 600 x 850	30-90	3,0	220 V	992,00
70612881320000	1200 x 600 x 850	30-90	3,0	220 V	1.050,00
70613881320000	1300 x 600 x 850	30-90	1,5	220 V	1.118,00
70614881320000	1400 x 600 x 850	30-90	1,5	220 V	1.176,00
70615881320000	1500 x 600 x 850	30-90	3,0	220 V	1.239,00
70616881320000	1600 x 600 x 850	30-90	3,0	220 V	1.302,00
70617881320000	1700 x 600 x 850	30-90	1,5	220 V	1.375,00
70618881320000	1800 x 600 x 850	30-90	1,5	220 V	1.438,00
70619881320000	1900 x 600 x 850	30-90	3,0	220 V	1.501,00
70710881320000	1000 x 700 x 850	30-90	1,5	220 V	992,00
70711881320000	1100 x 700 x 850	30-90	3,0	220 V	1.050,00
70712881320000	1200 x 700 x 850	30-90	3,0	220 V	1.123,00
70713881320000	1300 x 700 x 850	30-90	1,5	220 V	1.191,00
70714881320000	1400 x 700 x 850	30-90	1,5	220 V	1.254,00
70715881320000	1500 x 700 x 850	30-90	3,0	220 V	1.323,00
70716881320000	1600 x 700 x 850	30-90	3,0	220 V	1.386,00
70717881320000	1700 x 700 x 850	30-90	1,5	220 V	1.470,00
70718881320000	1800 x 700 x 850	30-90	1,5	220 V	1.533,00
70719881320000	1900 x 700 x 850	30-90	3,0	220 V	1.601,00



DOLAPLI ÇALIŞMA TEZGAHI KAHVE ÇEKMECELİ
CUPBOARD WORK TABLE WITH COFFEE DRAWERS

KOD Code	EBAT Size (mm)			HACİM VOLUME (m³)	FİYAT PRICE €
	L	W	H		
70612801700000	1200	600	850	0,670	1.200,00



KÖMÜRLÜ IZGARA DAĞLUMBAZI
HOOD WITH COAL GRILL

KOD Code	EBAT Size (mm)			AĞIRLIK Weight (kg)	FİYAT PRICE €
	L	W	H		
60306102	1000	650	1150	32	615,00
60306152	1500	650	1150	42	715,00
60306202	2000	650	1150	52	815,00
60306252	2500	650	1150	65	950,00



BLOK ÇEKMECE ÜNİTESİ
WORK TABLE WITH DRAWERS

KOD Code	EBAT Size (mm)			HACİM VOLUME (m³)	FİYAT PRICE €
	L	W	H		
70706801800000	600	600	850	0,40	650,00
70606801800000	700	600	850	0,46	750,00



KÖMÜRLÜ IZGARA
COAL GRILL

KOD Code	EBAT Size (mm)			AĞIRLIK Weight (kg)	FİYAT PRICE €
	L	W	H		
801092100	920	500	250	88	575,00
801142100	1420	500	250	116	730,00
801192100	1920	500	250	144	1.050,00
801242100	2420	500	250	165	1.350,00



BONE / GALOŞ DOLABI
BONNET / OVERSHOE CABINET

KOD Code	EBAT Size (cm)	FİYAT PRICE €
99130140002	47 x 25 x 82	472,00



KÖMÜRLÜ IZGARA MODÜLÜ
COAL GRILL MODULE

KOD Code	TİP Type	AĞIRLIK Weight (kg)	FİYAT PRICE €
805532200	Yuvarlak / Round - 500	20	250,00
805532201	V Tipi / V Type - 500	18	200,00



DUVAR TİPİ DAĞLUMBAZ FİLTRELİ
WALL TYPE HOOD WITH FILTER

KOD Code	EBAT Size (mm)	AĞIRLIK Weight (kg)	FİYAT PRICE €
60110101	1000x1000x500	34	582,00
60110151	1500x1000x500	44	787,00
60112151	1500x1200x500	48	850,00
60115151	1500x1500x500	58	934,00
60110201	2000x1000x500	72	987,00
60112201	2000x1200x500	97	1.065,00
60115201	2000x1500x500	85	1.176,00
60115231	2300x1500x500	95	1.312,00
60110251	2500x1000x500	105	1.181,00
60112251	2500x1200x500	44	1.265,00
60115251	2500x1500x500	54	1.391,00
60110301	3000x1000x500	64	1.375,00
60112301	3000x1200x500	75	1.475,00
60115301	3000x1500x500	84	1.617,00
60110351	3500x1000x500	95	1.686,00
60112351	3500x1200x500	106	1.806,00
60115351	3500x1500x500	146	1.989,00
60110401	4000x1000x500	49	1.874,00
60112401	4000x1200x500	60	2.016,00
60115401	4000x1500x500	72	2.215,00
60110451	4500x1000x500	83	2.089,00
60112451	4500x1200x500	93	2.231,00
60115451	4500x1500x500	105	2.446,00
60110501	5000x1000x500	117	2.268,00
60112501	5000x1200x500	129	2.425,00
60115501	5000x1500x500	140	2.656,00
60110551	5500x1000x500	154	2.478,00
60112551	5500x1200x500	170	2.509,00
60115551	5500x1500x500	195	2.562,00

DUVAR TİPİ DAĞLUMBAZ FİLTRESİZ
WALL TYPE HOOD WITHOUT FILTER

KOD Code	EBAT Size (mm)	AĞIRLIK Weight (kg)	FİYAT PRICE €
60110102	1000x1000x500	34	430,00
60106102	1000x600x500	28	299,00
60110152	1500x1000x500	44	561,00
60112152	1500x1200x500	48	624,00
60115152	1500x1500x500	58	724,00
60110202	2000x1000x500	72	693,00
60112202	2000x1200x500	97	766,00
60115202	2000x1500x500	85	876,00
60115232	2300x1500x500	95	971,00
60110252	2500x1000x500	105	819,00
60112252	2500x1200x500	44	908,00
60115252	2500x1500x500	54	1.034,00
60110302	3000x1000x500	64	950,00
60112302	3000x1200x500	75	1.039,00
60115302	3000x1500x500	84	1.186,00
60110352	3500x1000x500	95	1.155,00
60112352	3500x1200x500	106	1.275,00
60115352	3500x1500x500	146	1.459,00
60110402	4000x1000x500	49	1.270,00
60112402	4000x1200x500	60	1.422,00
60115402	4000x1500x500	72	1.617,00
60110452	4500x1000x500	83	1.422,00
60112452	4500x1200x500	93	1.559,00
60115452	4500x1500x500	105	1.774,00
60110502	5000x1000x500	117	1.548,00
60112502	5000x1200x500	129	1.701,00
60115502	5000x1500x500	140	1.932,00
60110552	5500x1000x500	154	1.701,00
60112552	5500x1200x500	170	1.732,00
60115552	5500x1500x500	195	1.785,00

Filtre / Filter (50x50): 40 €

Dağlumbaz Aydınlatması / Hood Lighting (650x76x160): 130 €



ORTA TİP DAĞLUMBAZ FİLTRELİ
MIDDLE TYPE HOOD WITH FILTER

KOD Code	EBAT Size (mm)	AĞIRLIK Weight (kg)	FİYAT PRICE €
60215151	1500x1500x500	68	1.070,00
60215201	2000x1500x500	81	1.345,00
60220201	2000x2000x500	97	1.520,00
60223201	2000x2300x500	72	1.615,00
60215251	2500x1500x500	121	1.600,00
60220251	2500x2000x500	137	1.805,00
60223251	2500x2300x500	153	1.915,00
60215301	3000x1500x500	169	1.855,00
60220301	3000x2000x500	185	2.090,00
60223301	3000x2300x500	201	3.025,00
60215351	3500x1500x500	107	2.285,00
60220351	3500x2000x500	114	2.565,00
60223351	3500x2300x500	120	2.740,00
60215401	4000x1500x500	133	2.555,00
60220401	4000x2000x500	150	2.860,00
60223401	4000x2300x500	167	3.050,00
60215451	4500x1500x500	184	2.820,00
60220451	4500x2000x500	201	3.160,00
60223451	4500x2300x500	218	3.360,00
60215501	5000x1500x500	116	3.064,00
60220501	5000x2000x500	134	3.430,00
60223501	5000x2300x500	149	3.645,00
60215551	5500x1500x500	167	3.355,00
60220551	5500x2000x500	210	3.750,00
60223551	5500x2300x500	250	3.990,00
60215581	5800x1500x500	270	3.520,00
60220581	5800x2000x500	321	3.930,00
60223581	5800x2300x500	370	4.175,00

Filtre / Filter (50x50): 40 €

Dağlumbaz Aydınlatması / Hood Lighting (650x76x160): 130 €

ORTA TİP DAĞLUMBAZ FİLTRESİZ
MIDDLE TYPE HOOD WITHOUT FILTER

KOD Code	EBAT Size (mm)	AĞIRLIK Weight (kg)	FİYAT PRICE €
60215152	1500x1500x500	68	695,00
60215202	2000x1500x500	81	850,00
60220202	2000x2000x500	97	1.025,00
60223202	2000x2300x500	72	1.130,00
60215252	2500x1500x500	121	995,00
60220252	2500x2000x500	137	1.200,00
60223252	2500x2300x500	153	1.320,00
60215302	3000x1500x500	169	1.135,00
60220302	3000x2000x500	185	1.365,00
60223302	3000x2300x500	201	1.500,00
60215352	3500x1500x500	107	1.405,00
60220352	3500x2000x500	114	1.690,00
60223352	3500x2300x500	120	1.860,00
60215402	4000x1500x500	133	1.555,00
60220402	4000x2000x500	150	1.870,00
60223402	4000x2300x500	167	2.060,00
60215452	4500x1500x500	184	1.710,00
60220452	4500x2000x500	201	2.050,00
60223452	4500x2300x500	218	2.250,00
60215502	5000x1500x500	116	1.860,00
60220502	5000x2000x500	134	2.230,00
60223502	5000x2300x500	149	2.445,00
60215552	5500x1500x500	167	2.015,00
60220552	5500x2000x500	210	2.405,00
60223552	5500x2300x500	250	2.640,00
60215582	5800x1500x500	270	2.105,00
60220582	5800x2000x500	321	2.520,00
60223582	5800x2300x500	370	2.760,00

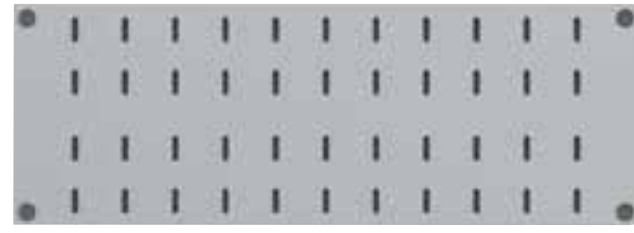

İSTİF RAFI DÜZ STACKING SHELF

KOD Code	EBAT Size (mm)			HACİM VOLUME (m ³)	FİYAT PRICE €
	L	W	H		
70036150000910	910	360	40	0,017	68,00
70036150000122	1220	360	40	0,023	73,00
70036150000137	1370	360	40	0,026	78,00
70036150000150	1500	360	40	0,028	84,00
70036150000183	1830	360	40	0,034	89,00
70046150000910	910	460	40	0,022	78,00
70046150000122	1220	460	40	0,029	84,00
70046150000137	1370	460	40	0,032	90,30
70046150000150	1500	460	40	0,035	96,00
70046150000183	1830	460	40	0,043	102,90

İSTİF RAFI PERFORELİ STACKING SHELF PERFORATED

KOD Code	EBAT Size (mm)			HACİM VOLUME (m ³)	FİYAT PRICE €
	L	W	H		
70036150100910	910	360	40	0,017	73,00
70036150100122	1220	360	40	0,023	78,00
70036150100137	1370	360	40	0,026	86,00
70036150100150	1500	360	40	0,028	92,00
70036150100183	1830	360	40	0,034	99,00
70046150100910	910	460	40	0,022	86,00
70046150100122	1220	460	40	0,029	92,00
70046150100137	1370	460	40	0,032	99,00
70046150100150	1500	460	40	0,035	107,00
70046150100183	1830	460	40	0,043	113,00

İSTİF RAFLARI 4 KATLI DÜZ FOUR STOREY STOWAGE SHELF

KOD Code	EBAT Size (mm)			HACİM VOLUME (m ³)	FİYAT PRICE €
	L	W	H		
70036450000910	910	360	1830	0,058	315,00
70036450000122	1220	360	1830	0,077	341,00
70036450000137	1370	360	1830	0,087	365,00
70036450000150	1500	360	1830	0,095	390,00
70036450000183	1830	360	1830	0,116	415,80
70046450000910	910	460	1830	0,074	362,00
70046450000122	1220	460	1830	0,098	383,00
70046450000137	1370	460	1830	0,110	408,00
70046450000150	1500	460	1830	0,121	435,00
70046450000183	1830	460	1830	0,147	462,00

İSTİF RAFLARI 4 KATLI PERFORELİ FOUR STOREY STOWAGE PERFORATED SHELF

KOD Code	EBAT Size (mm)			HACİM VOLUME (m ³)	FİYAT PRICE €
	L	W	H		
70036450100910	910	360	1830	0,058	346,00
70036450100122	1220	360	1830	0,077	378,00
70036450100137	1370	360	1830	0,087	404,00
70036450100150	1500	360	1830	0,095	429,00
70036450100183	1830	360	1830	0,116	456,00
70046450100910	910	460	1830	0,074	393,00
70046450100122	1220	460	1830	0,098	421,00
70046450100137	1370	460	1830	0,110	451,00
70046450100150	1500	460	1830	0,121	477,00
70046450100183	1830	460	1830	0,147	504,00



Bar Üniteleri Bar Units



www.kayalarmutfak.com.tr

444 5 957





BAR MODÜLÜ BUZDOLAPLI
BAR MODULE WITH COOLER

Kod / Code : 207490077010
Boyut / Size (mm) : 1400 x 700 x 900
Voltaj / Voltage : 230V 1+N
Güç / Power(Kw) : 0,26 kW
Paket Ölç./Pkg Dim(mm) : 1450 x 750 x 1000
Fiyat / Price € : 2.800,00 €



BAR MODÜLÜ ALT STANDLI
BAR MODULE WITH STAND

Kod / Code : 7171492110
Boyut / Size (mm) : 1400 x 700 x 900
Paket Ölç./Pkg Dim(mm) : 1450 x 750 x 1000
Fiyat / Price € : 1.150,00 €



MİNİ BAR MODÜLÜ ALT STANDLI
MINI BAR MODULE WITH STAND

Kod / Code : 7170892110
Boyut / Size (mm) : 800 x 700 x 900
Paket Ölç./Pkg Dim(mm) : 850 x 750 x 1000
Fiyat / Price € : 650,00 €



BAR ŞİŞE STANDI
BAR BOTTLE STAND

Kod / Code : 7170598100
Boyut / Size (mm) : 500 x 700 x 900
Paket Ölç./Pkg Dim(mm) : 550 x 750 x 1000
Fiyat / Price € : 550,00 €



BAR EVYESİ MODÜLÜ
BAR SINK MODULE

Kod / Code : 7170593100
Boyut / Size (mm) : 500 x 700 x 900
Paket Ölç./Pkg Dim(mm) : 550 x 750 x 1000
Fiyat / Price € : 550,00 €



BAR PREMİX TEZGAHI (SIRTLI)
BAR PREMIX TABLE (WITH SPLASH BACK)

Kod / Code : 7171497100
Boyut / Size (mm) : 1400 x 700 x 900
Paket Ölç./Pkg Dim(mm) : 1450 x 750 x 1000
Fiyat / Price € : 750,00 €



BAR BARDAK SÜZME MODÜLÜ
BAR CUP STRAINING MODULE

Kod / Code : 7170891100
Boyut / Size (mm) : 800 x 700 x 900
Paket Ölç./Pkg Dim(mm) : 850 x 750 x 1000
Fiyat / Price € : 500,00 €



BAR EVYE - ÇÖP VE BULAŞIK MODÜLÜ
BAR SINK - WASTE AND DISH MODULE
Kod / Code : 7171696100
Boyut / Size (mm) : 1600 x 700 x 900
Paket Ölç./Pkg Dim(mm) : 1650 x 750 x 1000
Fiyat / Price € : 650,00 €



BAR EVYE - ÇÖP MODÜLÜ
BAR SINK AND WASTE MODULE
Kod / Code : 7171095100
Boyut / Size (mm) : 1000 x 700 x 900
Paket Ölç./Pkg Dim(mm) : 1050 x 750 x 1000
Fiyat / Price € : 500,00 €



BAR ÇÖP MODÜLÜ
BAR WASTE MODULE
Kod / Code : 7170594100
Boyut / Size (mm) : 500 x 700 x 900
Paket Ölç./Pkg Dim(mm) : 550 x 750 x 1000
Fiyat / Price € : 200,00 €

ÇÖP KOVALARI FİYATA DAHİL DEĞİLDİR. / TRASH BINS ARE NOT INCLUDED TO THE PRICES

Açık Büfe Üniteleri

Buffet & Service Units



www.kayalarmutfak.com.tr

444 5 957



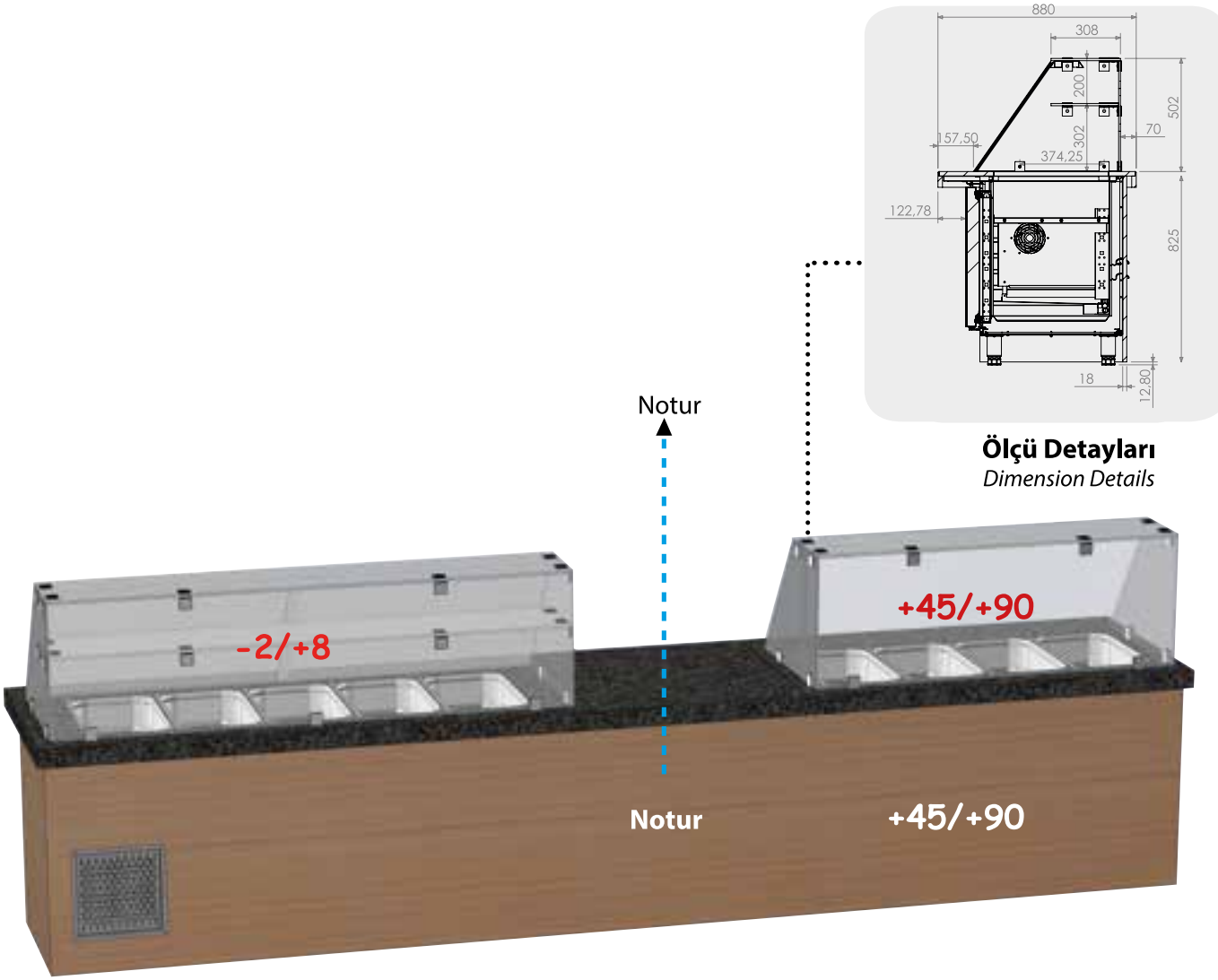

Ölçü Detayları
Dimension Details



+45/+90

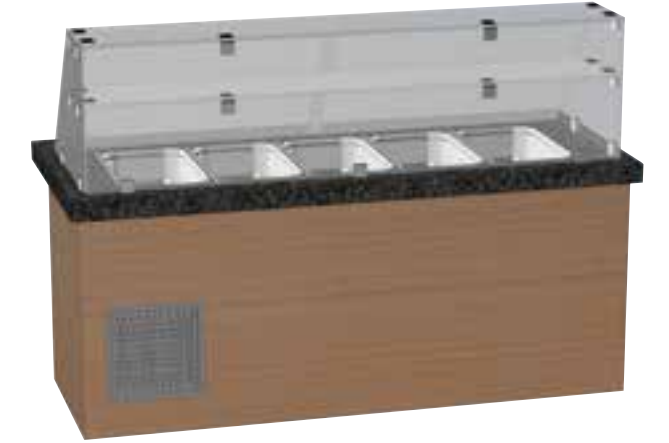

-2/+8

Farklı Ahşap kaplama ve granit seçenekleri için fiyat sorunuz.
Different wood cover and granite options are available. Ask for price

Plexi sürgü kapak
Plexi sliding cover

2 Kapı / Doors
3 Kapı / Doors
4 Kapı / Doors

Kaplama Renk Opsiyonları /
Back Cover Colour Options

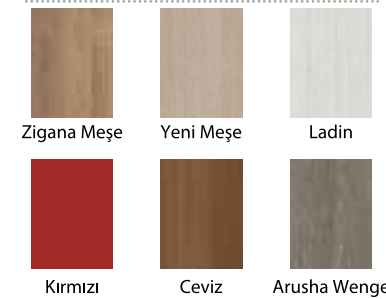

Bilgi

- * İç Gövde Paslanmaz Çelik
- * Dış Gövde Paslanmaz Çelik
- * İç Derinlik: 53 Cm (GN 1/1 Kapasiteli)
- * 35 / 40 Kg/m³ Çevre Dostu HCFC Free
- * Poliüretan İzolasyon
- * Dijital Kumanda Paneli
- * Elektrik Rezistanslı Otomatik Defrost
- * Yüksekliği Ayarlanabilir Paslanmaz Ayaklar
- * Özel Kapı ve Menteşe Sistemi
- * Temizlenebilir ve Sökülebilir Manyetik Kapı Contası
- * CFC Free Soğutma Gazı: R 134 A / R 404 A
- * Dış Ortam Sıcaklığı + 43 °C & % 65 Nem
- * Sıcak Ünitelerde Yukarı Bölüm Ben-Mari
- * Müşteri tarafında 2 cm Ahşap Kaplama
- * Buzlu cam - Cam İçinde LED Işık
- * Işıklı Cam Bölüm
- * 88 Cm 2 Cm Granit Üst Tabla

Info

- * Inside Body Stainless Steel
- * Outside Body Stainless Steel
- * Inside Depth: 53 Cm (GN 1/1 Capacity)
- * 35 / 40 Kg/m³ Ecology Friendly HCFC
- * Polyurethane Insulation
- * Digital Control Panel
- * Electrical Resistor Automatic Defrost
- * Stainless Steel Legs Adjustable for Height
- * Special Door and Hinge Systems
- * Removable and Easy Cleaning Magnetic Gasket
- * Cooling Gas CFC Free: R 134 A / R 404 A
- * Ambient Temperature + 43 °C & % 65 Nem
- * In Hot Units the Top is Ben-Marie & Lower
- * At the front 2 cm Wood Cover
- * Iced Glass with Inside LED Lighting
- * Glass Cover with LED Light
- * 88 Cm 2 Cm Granite Top

KOD CODE	İÇ SICAKLIK INTERIOR TEMP.	HACİM VOLUME	GÜÇ POWER	EBATLAR DIMENSIONS	PAKET ÖLÇÜSÜ PACKING DIM.	AĞIRLIK WEIGHT	FİYAT PRICE
	°C	Lt.	kW	mm	mm	Kg.	€
207680012061	-2 / +8	3 Gn 1/1 x 100	0,35	1180 x 880 x 850 / 1350	1300 x 1000 x 1100	170	2.385,00
207180011061	-2 / +8	4 Gn 1/1 x 100	0,38	1500 x 880 x 850 / 1350	1600 x 1000 x 1100	180	2.790,00
207380111061	-2 / +8	5 Gn 1/1 x 100	0,47	2000 x 880 x 850 / 1350	2100 x 1000 x 1100	220	3.375,00
207581111061	-2 / +8	6 Gn 1/1 x 100	0,55	2500 x 880 x 850 / 1350	2600 x 1000 x 1100	250	3.850,00
3106901020	Notur	-	-	600 x 880 x 850	720 x 900 x 1100	50	765,00
3108901020	Notur	-	-	800 x 880 x 850	920 x 900 x 1100	40	955,00
3112901222	+40 / +90	3 Gn 1/1 x 100	1,0	1180 x 880 x 850 / 1350	1300 x 1000 x 1100	170	2.025,00
3115901222	+40 / +90	4 Gn 1/1 x 100	1,0	1500 x 880 x 850 / 1350	1600 x 1000 x 1100	180	2.415,00
3120901222	+40 / +90	5 Gn 1/1 x 100	1,0	2000 x 880 x 850 / 1350	2100 x 1000 x 1100	220	2.850,00
3125901222	+40 / +90	6 Gn 1/1 x 100	1,0	2500 x 880 x 850 / 1350	2600 x 1000 x 1100	270	3.285,00

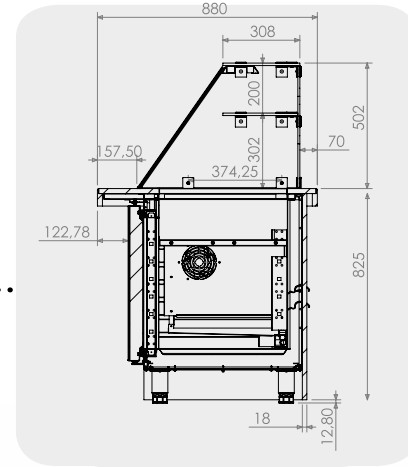

Ölçü Detayları
Dimension Details

Notur

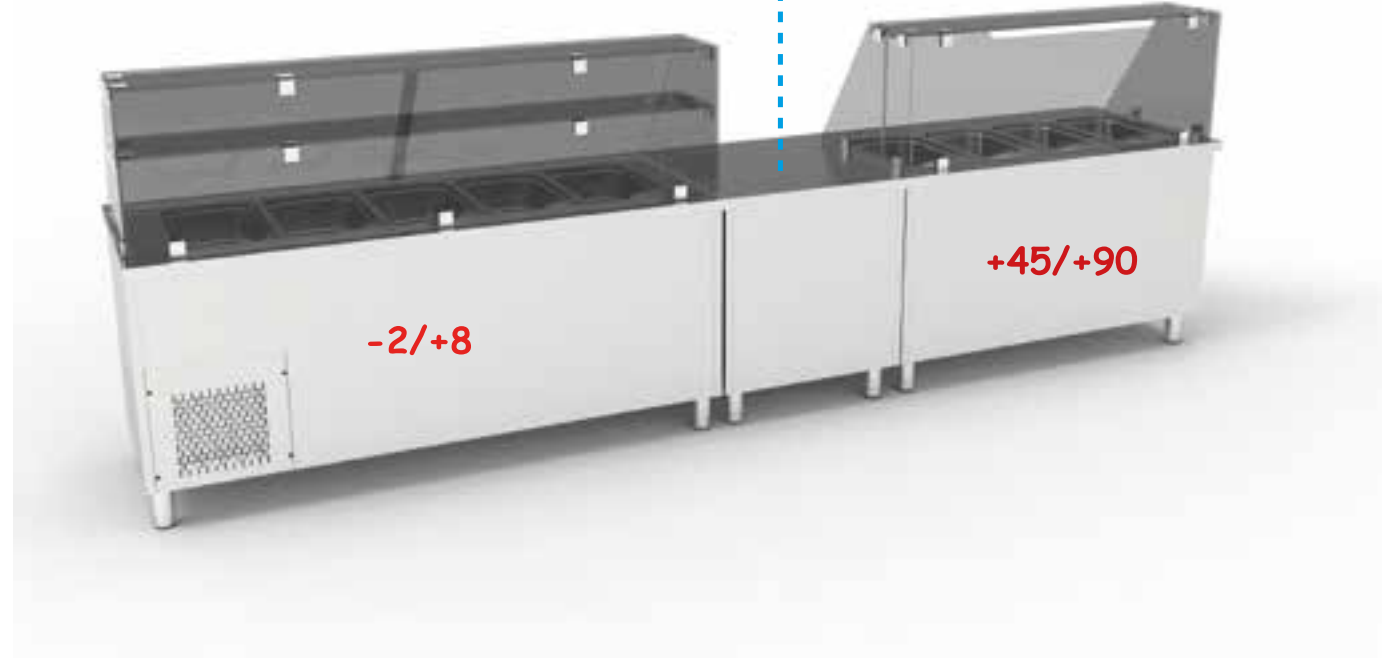

+45/+90

-2/+8

Bilgi

- * İç Gövde Paslanmaz Çelik
- * Dış Gövde Paslanmaz Çelik
- * İç Derinlik: 53 Cm (GN 1/1 Kapasiteli)
- * 35 / 40 Kg/m³ Çevre Dostu HCFC Free
- * Poliüretan İzolasyon
- * Dijital Kumanda Paneli
- * Elektrik Rezistanslı Otomatik Defrost
- * Yüksekliği Ayarlanabilir Paslanmaz Ayaklar
- * Özel Kapı ve Menteşe Sistemi
- * Temizlenebilir ve Sökülebilir Manyetik Kapı Contası
- * CFC Free Soğutma Gazı: R 134 A / R 404 A
- * Dış Ortam Sıcaklığı + 43 °C & % 65 Nem
- * Sıcak Ünitelerde Yukarı Bölüm Ben-Marie
- * Müşteri tarafında 2 cm Ahşap Kaplama
- * Buzlu cam - Cam İçinde LED Işık
- * Işıklı Cam Bölüm
- * 88 Cm 2 Cm Granit Üst Tabla

Info

- * Inside Body Stainless Steel
- * Outside Body Stainless Steel
- * Inside Depth: 53 Cm (GN 1/1 Capacity)
- * 35 / 40 Kg/m³ Ecology Friendly HCFC
- * Polyurethane Insulation
- * Digital Control Panel
- * Electrical Resistor Automatic Defrost
- * Stainless Steel Legs Adjustable for Height
- * Special Door and Hinge Systems
- * Removable and Easy Cleaning Magnetic Gasket
- * Cooling Gas CFC Free: R 134 A / R 404 A
- * Ambient Temperature + 43 °C & % 65 Nem
- * In Hot Units the Top is Ben-Marie & Lower
- * At the front 2 cm Wood Cover
- * Iced Glass withinside LED Lighting
- * Glass Cover with LED Light
- * 88 Cm 2 Cm Granite Top



+45/+90

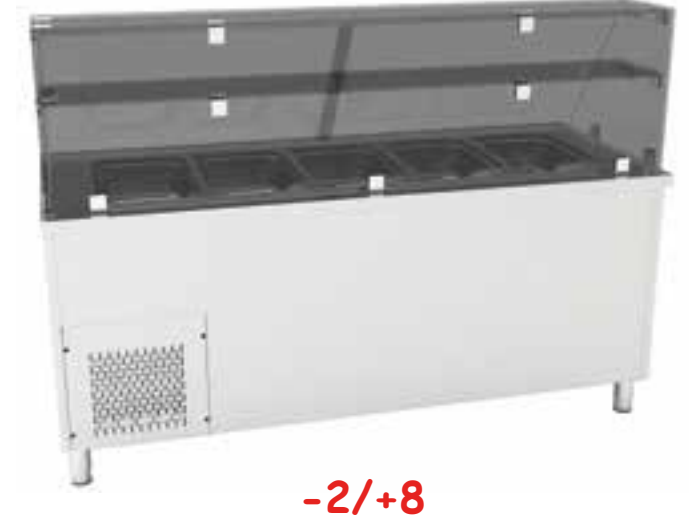

-2/+8

Plexi sürgü kapak
Plexi sliding cover

2 Kapı / Doors

3 Kapı / Doors

4 Kapı / Doors



Nötr

KOD CODE	İÇ SICAKLIK INTERIOR TEMP.	HACİM VOLUME	GÜÇ POWER	EBATLAR DIMENSIONS	PAKET ÖLÇÜSÜ PACKING DIM.	AĞIRLIK WEIGHT	FİYAT PRICE
	°C	Lt.	kW	mm	mm	Kg.	€
207680012021	-2 / +8	3 Gn 1/1 x 100	0,35	1105 x 800 x 850 /1350	1300 x 1000 x 1100	170	2.070,00
207180011021	-2 / +8	4 Gn 1/1 x 100	0,38	1430 x 800 x 850 /1350	1600 x 1000 x 1100	180	2.335,00
207380011021	-2 / +8	5 Gn 1/1 x 100	0,47	1910 x 800 x 850 /1350	2100 x 1000 x 1100	220	2.530,00
207581111021	-2 / +8	6 Gn 1/1 x 100	0,55	2400 x 800 x 850 /1350	2600 x 1000 x 1100	250	2.790,00
3105900000	Notur	-	-	520 x 800 x 850	720 x 900 x 1100	50	675,00
3107900000	Notur	-	-	720 x 800 x 850	920 x 900 x 1100	70	790,00
3111900202	+40 / +90	3 Gn 1/1 x 100	1,0	1105 x 800 x 850 /1350	1300 x 1000 x 1100	170	1.755,00
3114900202	+40 / +90	4 Gn 1/1 x 100	1,0	1430 x 800 x 850 /1350	1600 x 1000 x 1100	180	2.210,00
3119900202	+40 / +90	5 Gn 1/1 x 100	1,0	1910 x 800 x 850 /1350	2100 x 1000 x 1100	220	2.475,00
3124900202	+40 / +90	6 Gn 1/1 x 100	1,0	2400 x 800 x 850 /1350	2600 x 1000 x 1100	270	2.835,00



SERVİS HATTI SERVICE LINE



- Elektrikli
- GN 1/1 4, 5 ve 6 Hazneli
- Termostatik kontrollüdür.
- Boşaltma vanalı

- Electrical
- With GN 1/1 4, 5 ve 6 reservoir
- Thermostat controlled
- With drain valve

SICAK SERVİS ÜNİTESİ
HOT SERVICE UNIT

KOD Code	Tipi Type	EBAT Size (mm)	AĞIRLIK Weight (kg)	FİYAT PRICE €
3012000202	ELEKTRİKLİ	1200 x 700 x 850 3 x Gn 1/1 150	85	1.220,00
3015000202	ELEKTRİKLİ	1500 x 700 x 850 4 x Gn 1/1 150	99	1.300,00
3018000202	ELEKTRİKLİ	1800 x 700 x 850 5 x Gn 1/1 150	118	1.520,00
3021000202	ELEKTRİKLİ	2100 x 700 x 850 6 x Gn 1/1 150	133	1.725,00

KÜVET, KAYDIRMA STANDI VE SERVİS RAFI FİYATLARA DAHİL DEĞİLDİR.
GN CONTAINER, SLIDING STAND & SHELF PRICES ARE NOT INCLUDED.



- Elektrikli
- GN 1/1 4, 5 ve 6 Hazneli
- Termostatik kontrollüdür.
- Boşaltma vanalı
- Electrical
- With GN 1/1 4, 5 ve 6 reservoir
- Thermostat controlled
- With drain valve

SOĞUK SERVİS ÜNİTESİ
COLD SERVICE UNIT

KOD Code	EBAT Size (mm)	AĞIRLIK Weight (kg)	FİYAT PRICE €
3012000302	1200 x 700 x 850 3 x Gn 1/1 100	85	1.500,00
3015000302	1500 x 700 x 850 4 x Gn 1/1 100	99	1.650,00
3018000302	1800 x 700 x 850 5 x Gn 1/1 100	118	1.850,00
3021000302	2100 x 700 x 850 6 x Gn 1/1 100	133	2.100,00



NÖTR SERVİS ÜNİTESİ
NEUTRAL SERVICE UNIT

KOD Code	EBAT Size (mm)	AĞIRLIK Weight (kg)	FİYAT PRICE €
3007000000	700 x 700 x 850	60	650,00
3009000000	900 x 700 x 850	75	750,00
3012000000	1200 x 700 x 850	102	900,00
3015000000	1500 x 700 x 850	121	1.100,00

KÜVET, KAYDIRMA STANDI VE SERVİS RAFI FİYATLARA DAHİL DEĞİLDİR.
GN CONTAINER, SLIDING STAND & SHELF PRICES ARE NOT INCLUDED.



KULE TİP DOLAP
TOWER TYPE CUPBOARD

KOD Code	GÜÇ POWER (W)	VOLTAJ VOLTAGE	EBAT Size (mm)	FİYAT PRICE €
99050390007	0,55	230V 50-60Hz	1500 x 700 x 1600	4.500,00
99050390039	0,55	230V 50-60Hz	1900 x 700 x 1600	5.500,00



KÖŞE TEZGAHI (İÇ & DIŞ KÖŞE)
CORNER WORKING TABLE (INNER & OUTER CORNER)

KOD Code	EBAT Size (mm)	AĞIRLIK Weight (kg)	FİYAT PRICE €
3098000000	90° Dış Köşe	85	675,00
3099000000	90° İç Köşe	85	675,00

KÜVET, KAYDIRMA STANDI VE SERVİS RAFI FİYATLARA DAHİL DEĞİLDİR.
GN CONTAINER, SLIDING STAND & SHELF PRICES ARE NOT INCLUDED.



KASA TEZGAHI
CASH DESK

KOD Code	AÇIKLAMA DESCRIPTION	EBAT Size (mm)	AĞIRLIK Weight (kg)	PRICE €
3012000500	SAĞ GİRİŞ	1200 x 700 x 850	70	800,00
3012000600	SOL GİRİŞ	1200 x 700 x 850	90	800,00

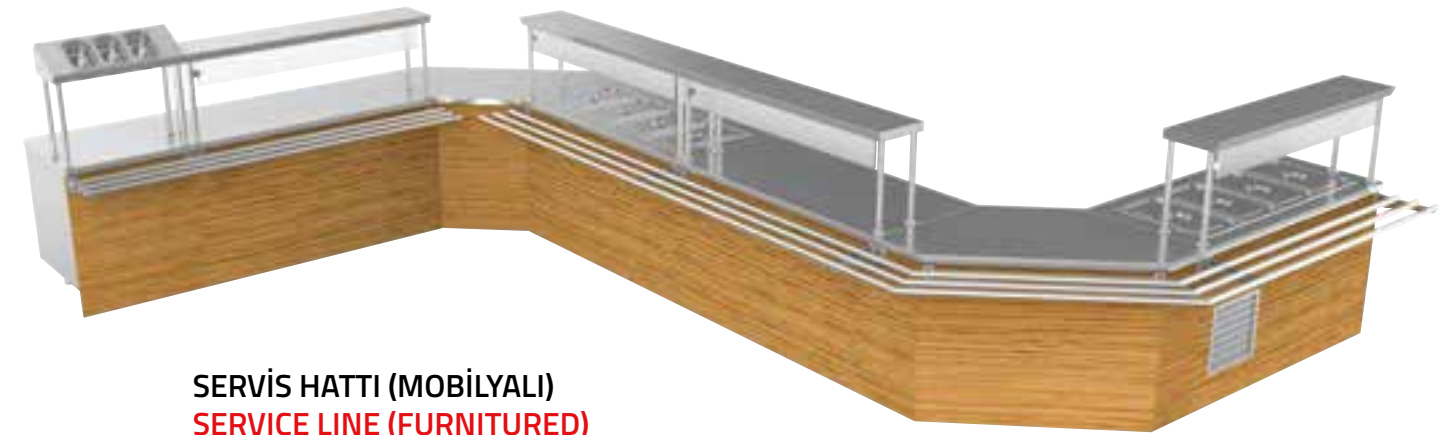

SERVİS HATTI (MOBİLYALI)
SERVICE LINE (FURNITURED)



- Elektrikli
- GN 1/1 4, 5 ve 6 Hazneli
- Termostatik kontrollüdür.
- Boşaltma vanalı
- Electrical
- With GN 1/1 4, 5 ve 6 reservoir
- Thermostat controlled
- With drain valve

SICAK SERVİS ÜNİTESİ (MOBİLYALI) HOT SERVICE UNIT (FURNITURED)

KOD Code	Tipi Type	EBAT Size (mm)	AĞIRLIK Weight (kg)	FİYAT PRICE €
3012001202	ELEKTRİKLİ	1200 x 700 x 850 3 x Gn 1/1 150	85	1.450,00
3015001202	ELEKTRİKLİ	1500 x 700 x 850 4 x Gn 1/1 150	99	1.530,00
3018001202	ELEKTRİKLİ	1800 x 700 x 850 5 x Gn 1/1 150	118	1.750,00
3021001202	ELEKTRİKLİ	2100 x 700 x 850 6 x Gn 1/1 150	133	1.955,00



- Elektrikli
- GN 1/1 4, 5 ve 6 Hazneli
- Termostatik kontrollüdür.
- Boşaltma vanalı
- Electrical
- With GN 1/1 4, 5 ve 6 reservoir
- Thermostat controlled
- With drain valve

SOĞUK SERVİS ÜNİTESİ (MOBİLYALI) COLD SERVICE UNIT (FURNITURED)

KOD Code	MODEL	EBAT Size (mm)	AĞIRLIK Weight (kg)	FİYAT PRICE €
3012001302	ELEKTRİKLİ	1200 x 700 x 850 3 x Gn 1/1 100	85	1.680,00
3015001302	ELEKTRİKLİ	1500 x 700 x 850 4 x Gn 1/1 100	99	1.840,00
3018001302	ELEKTRİKLİ	1800 x 700 x 850 5 x Gn 1/1 100	118	2.070,00
3021001302	ELEKTRİKLİ	2100 x 700 x 850 6 x Gn 1/1 100	133	2.300,00

KÜVET, KAYDIRMA STANDI VE SERVİS RAFI FİYATLARA DAHİL DEĞİLDİR.
GN CONTAINER, SLIDING STAND & SHELF PRICES ARE NOT INCLUDED.



NÖTR SERVİS ÜNİTESİ (MOBİLYALI) NEUTRAL SERVICE UNIT (FURNITURED)

KOD Code	EBAT Size (mm)	AĞIRLIK Weight (kg)	FİYAT PRICE €
3007001000	700 x 700 x 850	60	630,00
3009001000	900 x 700 x 850	75	725,00
3012001000	1200 x 700 x 850	102	815,00
3015001000	1500 x 700 x 850	121	890,00



KULE TİP DOLAP (MOBİLYALI) TOWER TYPE CUPBOARD

KOD Code	GÜÇ Power (kW)	VOLTAJ	EBAT Size (mm)	FİYAT PRICE €
99050390008	0,55	230V 50-60Hz	1500 x 700 x 1600	5.400,00
99050390009	0,55	230V 50-60Hz	1900 x 700 x 1600	6.550,00



KÖŞE TEZGAHI (İÇ& DIŞ KÖŞE) MOBİLYALI
CORNER WORKING TABLE (INNER & OUTER) FURNITURED

KOD Code	EBAT Size (mm)	AĞIRLIK Weight (kg)	FİYAT PRICE €
3098001000	90° Dış Köşe	85	875,00
3099001000	90° İç Köşe	80	765,00



KASA TEZGAHI
CASH DESK

KOD Code	AÇIKLAMA DESCRIPTION	EBAT Size (mm)	AĞIRLIK Weight (kg)	FİYAT PRICE €
3012001500	SAĞ GİRİŞ	1200 x 700 x 850	70	1.000,00
3012001600	SOL GİRİŞ	1200 x 700 x 850	90	1.000,00



- Ekmek, çatal, bıçak, kaşık servisi için üretilmiştir.
- Isıtmasız, soğutmasız nötr bir ünedir.
- Made for distribute bread and forks, knives, spoons service
- It's a neutral unit.

KÜVER ÜNİTESİ MODÜLÜ
SERVICE UNIT MODULE

KOD Code	EBAT Size (mm)	AĞIRLIK Weight (kg)	FİYAT PRICE €
3107150000	700 (3 x Gn 1/4 150)	70	180,00
3109150000	900 (4 x Gn 1/4 150)	90	220,00

KÜVET, KAYDIRMA STANDI VE SERVİS RAFI FİYATLARA DAHİL DEĞİLDİR.
GN CONTAINER, SLIDING STAND & SHELF PRICES ARE NOT INCLUDED.



BARDAK ÜNİTESİ MODÜLÜ
SERVICE UNIT MODULE

KOD Code	EBAT Size (mm)	AĞIRLIK Weight (kg)	FİYAT PRICE €
3107160000	700 x 540 x 700		700,00



SERVİS RAFI (Lüx)
SERVICE SHELF (Lux)

KOD Code	EBAT Size (mm)	FİYAT PRICE €
3112140002	1200 x 300 x 500	320,00
3114140002	1400 x 300 x 500	360,00
3115140002	1500 x 300 x 500	400,00
3118140002	1800 x 300 x 500	450,00
3121140002	2100 x 300 x 500	500,00



SERVİS RAFI
SERVICE SHELF

KOD Code	EBAT Size (mm)	FİYAT PRICE €
3107120000	700 x 300 x 500	160,00
3109120000	900 x 300 x 500	200,00
3112120000	1200 x 300 x 500	230,00
3115120000	1500 x 300 x 500	265,00
3118120000	1800 x 300 x 500	295,00
3121120000	2100 x 300 x 500	330,00
3107130000	700 x 300 x 400 / 300	230,00
3109130000	900 x 300 x 400 / 300	265,00
3112130000	1200 x 300 x 400 / 300	295,00
3115130000	1500 x 300 x 400 / 300	330,00
3118130000	1800 x 300 x 400 / 300	360,00
3121130000	2100 x 300 x 400 / 300	395,00



KAYDIRMA STANDI
TRAY SLIDER

KOD Code	EBAT Size (mm)	FİYAT PRICE €
3107100000	700 x 300 x 100	110,00
3109100000	900 x 300 x 100	120,00
3112100000	1200 x 300 x 100	135,00
3115100000	1500 x 300 x 100	155,00
3118100000	1800 x 300 x 100	175,00
3121100000	2100 x 300 x 100	225,00



SELF SERVİS GRANİT TABLA
(Nötr Ürünler için)
SELF SERVICE GRANITE TABLE FOR NEUTRAL PRODUCT

EBAT Size (mm)	FİYAT PRICE €
900 x 700 x 20	Fiyat Sorunuz
1150 x 700 x 20	Fiyat Sorunuz
1470 x 700 x 20	Fiyat Sorunuz
1500 x 700 x 20	Fiyat Sorunuz
1800 x 700 x 20	Fiyat Sorunuz
1900 x 700 x 20	Fiyat Sorunuz
2100 x 700 x 20	Fiyat Sorunuz

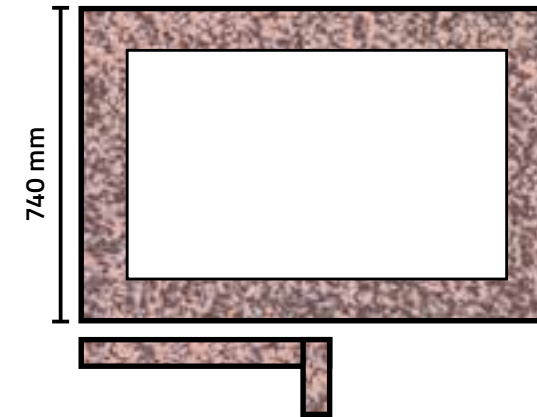

SELF SERVİS GRANİT TABLA
(Hazneli Ürünler için)
SELF SERVICE GRANITE TABLE FOR NEUTRAL PRODUCT

EBAT Size (mm)	FİYAT PRICE €
1150 x 700 x 20	Fiyat Sorunuz
1470 x 700 x 20	Fiyat Sorunuz
1800 x 700 x 20	Fiyat Sorunuz
2100 x 700 x 20	Fiyat Sorunuz



SELF SERVİS GRANİT TABLA
(Nötr Ürünler için)
SELF SERVICE GRANITE TABLE FOR NEUTRAL PRODUCT

EBAT Size (mm)	FİYAT PRICE €
900 x 700 x 20	Fiyat Sorunuz
1150 x 700 x 20	Fiyat Sorunuz
1470 x 700 x 20	Fiyat Sorunuz
1500 x 700 x 20	Fiyat Sorunuz
1800 x 700 x 20	Fiyat Sorunuz
1900 x 700 x 20	Fiyat Sorunuz
2100 x 700 x 20	Fiyat Sorunuz



SELF SERVİS GRANİT TABLA
(Hazneli Ürünler için)
SELF SERVICE GRANITE TABLE FOR NEUTRAL PRODUCT

EBAT Size (mm)	FİYAT PRICE €
1150 x 700 x 20	Fiyat Sorunuz
1470 x 700 x 20	Fiyat Sorunuz
1800 x 700 x 20	Fiyat Sorunuz
2100 x 700 x 20	Fiyat Sorunuz



TEŞHİR DOLABI DÜZ SOĞUK
COLD CAKE DISPLAY UNIT FLAT

KOD Code	MODEL	GÜÇ Power (kW)	İÇ SICAKLIK Temperatura	VOLTAJ Voltage	EBAT Size (mm)	AĞIRLIK Weight (kg)	FİYAT PRICE €
3200112001	ÇARPMA KAPILI - HINGED DOORS	0,35	+2 / +10	220 V	800x700x1350	90	2.800,00
3200112002	ÇARPMA KAPILI - HINGED DOORS	0,50	+2 / +10	220 V	1000x700x1350	110	3.120,00
3200112012	KAYAR KAPILI - SLIDING DOORS	0,50	+2 / +10	220 V	1000x700x1350	110	3.200,00
3200112013	KAYAR KAPILI - SLIDING DOORS	0,50	+2 / +10	220 V	1500x700x1350	160	4.160,00
3200112014	KAYAR KAPILI - SLIDING DOORS	0,50	+2 / +10	220 V	1800x700x1350	200	4.640,00



TEŞHİR DOLABI DÜZ SICAK
HOT CAKE DISPLAY UNIT FLAT

KOD Code	MODEL	GÜÇ Power (kW)	İÇ SICAKLIK Temperatura	VOLTAJ Voltage	EBAT Size (mm)	AĞIRLIK Weight (kg)	FİYAT PRICE €
3200102001	ÇARPMA KAPILI - HINGED DOORS	0,35	+30 / +60	220 V	800x700x1350	90,00	2.000,00
3200102002	ÇARPMA KAPILI - HINGED DOORS	0,50	+30 / +60	220 V	1000x700x1350	110,00	2.480,00
3200102012	KAYAR KAPILI - SLIDING DOORS	0,50	+30 / +60	220 V	1000x700x1350	110,00	2.560,00
3200102013	KAYAR KAPILI - SLIDING DOORS	0,50	+30 / +60	220 V	1500x700x1350	160,00	3.200,00



TEŞHİR DOLABI BOMBELİ SOĞUK
COLD CAKE DISPLAY UNIT CAMBERED

KOD Code	MODEL	GÜÇ Power (kW)	İÇ SICAKLIK Temperatura	VOLTAJ Voltage	EBAT Size (mm)	AĞIRLIK Weight (kg)	FİYAT PRICE €
3200111001	ÇARPMA KAPILI - HINGED DOORS	0,35	+2 / +10	220 V	800x700x1350	90	2.560,00
3200111002	ÇARPMA KAPILI - HINGED DOORS	0,50	+2 / +10	220 V	1000x700x1350	110	2.880,00
3200111012	KAYAR KAPILI - SLIDING DOORS	0,50	+2 / +10	220 V	1000x700x1350	110	2.960,00
3200111013	KAYAR KAPILI - SLIDING DOORS	0,50	+2 / +10	220 V	1500x700x1350	160	3.840,00



TEŞHİR DOLABI BOMBELİ SICAK
HOT CAKE DISPLAY UNIT CAMBERED

KOD Code	MODEL	GÜÇ Power (kW)	İÇ SICAKLIK Temperatura	VOLTAJ Voltage	EBAT Size (mm)	AĞIRLIK Weight (kg)	FİYAT PRICE €
3200101001	ÇARPMA KAPILI - HINGED DOORS	0,35	+30 / +60	220 V	800x700x1350	90	1.760,00
3200101002	ÇARPMA KAPILI - HINGED DOORS	0,50	+30 / +60	220 V	1000x700x1350	110	2.080,00
3200101012	KAYAR KAPILI - SLIDING DOORS	0,50	+30 / +60	220 V	1000x700x1350	110	2.960,00
3200101013	KAYAR KAPILI - SLIDING DOORS	0,50	+30 / +60	220 V	1500x700x1350	160	3.040,00



TEŞHİR DOLABI BOMBELİ ÖNÜ AÇIK
COLD CAKE DISPLAY UNIT CAMBERED (FRONT OPEN)

KOD Code	MODEL	GÜÇ Power (kW)	İÇ SICAKLIK Temperatura	VOLTAJ Voltage	EBAT Size (mm)	AĞIRLIK Weight (kg)	FİYAT PRICE €
3200113001	ÇARPMA KAPILI - HINGED DOORS	0,50	+2 / +10	220 V	800x700x1350	90	2.960,00
3200113002	ÇARPMA KAPILI - HINGED DOORS	0,50	+2 / +10	220 V	1000x700x1350	110	3.280,00



ET TEŞHİR ÜNİTESİ
MEAT DISPLAY UNIT

KOD Code	GÜÇ Power (kW)	İÇ SICAKLIK Temperatura	VOLTAJ Voltage	EBAT Size (mm)	AĞIRLIK Weight (kg)	FİYAT PRICE €
99050390040	0,50	+2 / +8	220V	1000 x 800 x 1150	110	4.200,00
99050390041	0,50	+2 / +8	220V	1500 x 800 x 1150	170	5.680,00
99050390042	0,60	+2 / +8	220V	1800 x 800 x 1150	210	6.800,00



SICAK SERVİS ÜNİTESİ
HOT SERVICE UNIT

KOD Code	GN KAPASİTE GN Capacity	GÜÇ Power (kW)	VOLTAJ Voltage	EBAT Size (mm)	FİYAT PRICE €
99050370050	GN 1/1 x 3 Adet	0,55	230V 50-60Hz	1210 x 900 x 850 / 125	1.650,00
99050370051	GN 1/1 x 4 Adet	0,55	230V 50-60Hz	1510 x 900 x 850 / 125	1.870,00
99050370052	GN 1/1 x 5 Adet	0,55	230V 50-60Hz	1810 x 900 x 850 / 125	2.750,00



SOĞUK SERVİS ÜNİTESİ
COLD SERVICE UNIT

KOD Code	GN KAPASİTE GN Capacity	GÜÇ Power (kW)	VOLTAJ Voltage	EBAT Size (mm)	FİYAT PRICE €
99050370053	GN 1/1 x 3 Adet	0,55	230V 50-60Hz	1210 x 900 x 850 / 125	2.200,00
99050370054	GN 1/1 x 4 Adet	0,55	230V 50-60Hz	1510 x 900 x 850 / 125	2.400,00
99050370055	GN 1/1 x 5 Adet	0,55	230V 50-60Hz	1810 x 900 x 850 / 125	3.300,00



NÖTR SERVİS ÜNİTESİ
NOTR SERVICE UNIT

KOD Code	GN KAPASİTE GN Capacity	GÜÇ Power (kW)	VOLTAJ Voltage	EBAT Size (mm)	FİYAT PRICE €
99050370056	GN 1/1 x 3 Adet	0,55	230V 50-60Hz	1210 x 900 x 850 / 125	1.450,00

KÜVETLER FİYATLARA DAHİL DEĞİLDİR.
GN CONTAINER PRICES ARE NOT INCLUDED.

Fast Food Hazirlık
Fast Food Preparation



444 5 957
kayalarmutfak.com.tr

Fast Food Hazirlık / Fast Food Preparation

HAMBURGER HAZIRLIK TEZGAHI
BURGER PREPARATION LINE

Boyut / Size : 2800 x 1400 x 1900

Kod / Code : 802281302

Fiyat / Price : 2.200,00 €



HAMBURGER HAZIRLIK TEZGAHI
BURGER PREPARATION LINE

Boyut / Size : 2900 x 1200 x 850 x 1850

Kod / Code : 802281402

Fiyat / Price : 5.000,00 €





**SICAK TUTUCU
HEAT HOLDING CABINETS**

Boyut / Size : 920 x 470 x 575

Kod / Code : 802951102

Fiyat / Price : 600,00 €



**PATATES DİNLENDİRME
CHIPS SCUTTLE**

Boyut / Size : 1000 x 850 x 850 x 1700

Kod / Code : 802180402

Fiyat / Price : 1.600,00 €



**PİZZA HAZIRLIK DOLABI
PIZZA PREPARATION REFRIGERATOR**

Boyut / Size : 2372 x 700 x 850

Kod / Code : 20728111910

Fiyat / Price : 3.600,00 €



**PİZZA HAZIRLIK TEZGAHI
PIZZA PREPARATION WORK TABLE**

Boyut / Size : 1300 x 1300 x 2000

Kod / Code : 802121702

Fiyat / Price : 1.000,00 €

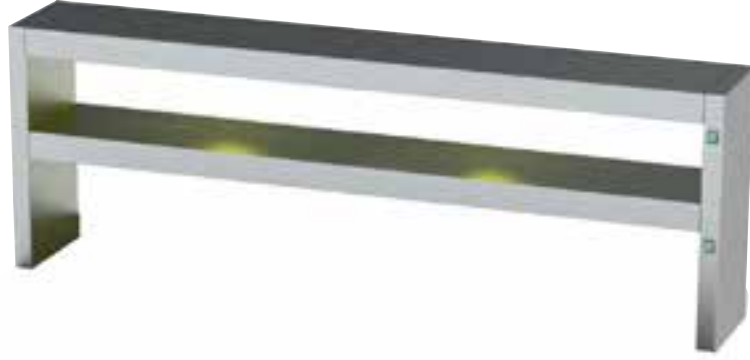

SALAMANDER

Boyut / Size : 1900 x 300
KOD / Code : 802192002
Fiyat / Price : 550,00 €

Boyut / Size : 1400 x 300
KOD / Code : 802142002
Fiyat / Price : 450,00 €



**PIZZA KUTU ISITMA RAFI
PIZZA HEATING SHELF**

Boyut / Size : 1650 x 500 x 1600
Kod / Code : 802111802
Fiyat / Price : 700,00 €

Taşıma Ekipmanları

Carriage Equipments



www.kayalarmutfak.com.tr

444 5 957





SICAK BANKET ARABASI
HOT BANQUET TROLLEY

KOD Code	ÇALIŞMA ARALIĞI	KAPASİTE Capacity (Lt.)	GÜÇ Power (kw)	VOLTAJ Voltage	EBAT Size (mm)	FİYAT PRICE €
3208000002	+30°C, +90°C	2/1 100 x 10	1,70	230V 1+N - 50/60Hz	820 x 920 x 1745	1.900,00

- Poliüretan gövde
- Termostat kontrol
- İç ısı göstergesi
- Kilitlenebilir tekerlek
- Polyurethane body
- Thermostat control
- Internal temperature display
- Lockable wheel



ELEKTRİKLİ TABAK ISITICI TEKLİ VE İKİLİ
ELECTRICAL PLATE HEATER SINGLE AND DOUBLE

KOD Code	MODEL Model	EBAT Size (mm)	GÜÇ Power (kW)	GERİLİM Voltage (V)	AĞIRLIK Weight (kg)	HACİM Volume (m3)	KAPASİTE Capacity (Plates)	FİYAT PRICE €
99050290012	KET101	450 x 485 x 770 Ø24cm - Ø32cm	0,4	230	31	0,17	50	700,00
99050290014	KET102	450 x 910 x 770 Ø24cm - Ø32cm	0,8	230	48	0,32	100	900,00



ORDÖVR TABAK TOPLAMA ARABASI
PLATE STACKING TROLLEY

KOD Code	KAPASİTE (tabak) Capacity (plate)	EBAT Size (mm)	FİYAT PRICE €
99130010011	100	750 x 750 x 1750 / 35 kg	600,00



TABAK TAŞIMA ARABASI AYARLANABİLİR 6 BÖLMELİ
PLATE TROLLEY ADJUSTABLE WITH 6 SECTION

KOD Code	KAPASİTE Capacity (Tabak)	EBAT Size (mm)	FİYAT PRICE €
99130010013	250 - 450	1100 x 710 x 800	990,00



PLASTİK SERVİS ARABASI
FLOOR CLEANING TROLLEY - PLASTIC

KOD Code	MODEL	EBAT Size (mm)	FİYAT PRICE €
99110230005	Plastik 3 Katlı	1070x520x960	275,00



ÇELİK SERVİS ARABASI 2 - 3 KATLI
SERVICE TROLLEY 2-3 SHELVES

KOD Code	MODEL	EBAT Size (mm)	FİYAT PRICE €
99110230019	2 KATLI	950x500x950	280,00
99110230020	3 KATLI	950x500x950	330,00



BULAŞIK TOPLAMA ARABASI
DISHES COLLECTING TROLLEY

KOD Code	MODEL	EBAT Size (mm)	FİYAT PRICE €
99050430002	2 Katlı	900 x 600 x 850	350,00



TEPSİ TOPLAMA ARABASI
TRAY COLLECTING TROLLEY

KOD Code	KAPASİTE (Tepsi) Capacity (Trays)	EBAT Size (mm)	FİYAT PRICE €
99110230008	15 ADET 37x53 Tepsi	440 x 570 x 1590	540,00
99110230012	15 + 15 Adet 37x53 Tepsi	840 x 570 x 1590	705,00
99110230010	15 + 15 + 15 Adet 37x53 Tepsi	1220 x 570 x 1590	780,00
99110230009	GN 1/1 17 Katlı	440 x 630 x 1720	540,00
99110230011	GN 2/1 17 Katlı	580 x 660 x 1720	580,00
99110230013	40x60 Tepsi 15 Adet	440 x 630 x 1650	540,00



YÜK TAŞIMA ARABASI
PLATFORM TROLLEY

KOD Code	EBAT Size (mm)	FİYAT PRICE €
99130010003	800 x 600 x 200 / 900	350,00



KAZAN TAŞIMA ARABASI
POR CARRYING TROLLEY

KOD Code	EBAT Size (mm)	FİYAT PRICE €
70609500010000	900 x 600 x 500 / 900	365,00



PLASTİK / ÇELİK UN - ŞEKER ARABASI PLASTİK
FLOUR AND SUGAR TROLLEY PLASTIC

KOD Code	MODEL Model	EBAT Size (mm)	HACİM Gross (lt)	FİYAT PRICE €
99130010005	PLASTİK	420 x 750 x 710	102	220,00
99130010016	ÇELİK-TEKLİ	450 x 600 x 500	50	330,00
99130010017	ÇELİK-ÇİFTLİ	850 x 600 x 500	100	590,00

Yardımcı Ekipmanlar

Kitchen Auxiliary Equipments



www.kayalarmutfak.com.tr

444 5 957





HELVANE TENCERE KAPAKLI / WIDE POT WITH LID

KOD Code	ÇAP Diameter (cm)	YÜKSEKLİK Height (cm)	KAPASİTE Capacity (Lt.)	FİYAT PRICE €
51011000003	30	15	9,5	54,00
51011000004	36	15	14	60,00
51011000005	36	20	18	68,00
51011000006	40	17	19	73,00
51011000007	45	20	28	90,00
51011000008	50	20	35	105,00
51011000009	55	20	43	120,00
51011000010	60	20	50	141,00
51011000011	65	25	75	170,00
51011000012	70	20	69	246,00
51011000013	70	30	104	258,00
51011000014	80	20	90	330,00
51011000015	80	30	136	350,00
51011000016	90	30	171	450,00
51011000001	100	30	211	600,00
51011000002	110	35	290	700,00
51011000017	110	60	550	1.750,00

KIZARTMA TAVASI ÇİFT SAPLI KAPAKSIZ / FRYING PAN D. H.

KOD Code	ÇAP Diameter (cm)	YÜKSEKLİK Height (cm)	KAPASİTE Capacity (Lt.)	FİYAT PRICE €
52006000001	36	9	9	60,00
52006000006	40	11	14	70,00
52006000007	45	12	19	84,00
52006000014	50	12	25	99,00
52006000008	55	14	31	120,00
52006000009	60	14	39	160,00
52006000010	65	14	46	200,00
52006000011	70	15	57	230,00
52006000012	80	16	80	320,00
52006000013	90	20	101	357,00
52006000003	100	18	141	430,00
52006000004	110	20	189	577,00

ÇELİK SÜZGEÇ KAPAKSIZ / STRAINER

KOD Code	ÇAP Diameter (cm)	YÜKSEKLİK Height (cm)	KAPASİTE Capacity (Lt.)	FİYAT PRICE €
51006000001	36	8	9	50,00
51006000002	40	10	14	55,00
51006000003	45	11	19	60,00
51006000004	50	11	25	75,00
51006000005	55	13	31	80,00
51006000006	60	13	39	84,00
51006000007	65	13	46	100,00
51006000008	70	14	57	126,00
51006000009	80	15	80	170,00
51006000010	90	18	101	230,00
51006000011	100	18	141	300,00
51006000012	110	18	162	360,00



SİLİNDİRİK DERİN TENCERE KAPAKLI
CYLINDRICAL STEW POT DEEP WITH LID



KOD Code (Mat - Satin)	ÇAP Diameter (cm)	YÜKSEKLİK Height (cm)	KAPASİTE Capacity (Lt.)	FİYAT PRICE €
51016000002	16	16	3,1	30,00
51016000004	18	18	4,4	32,00
51016000007	20	20	6,1	36,00
51016000011	24	20	8,8	47,00
51016000012	24	24	11	52,00
51016000015	28	28	17	72,00
51016000034	30	30	21	78,00
51016000018	32	32	25	96,00
51016000020	35	35	33	113,00
51016000023	40	40	49	139,00
51016000026	45	45	69	200,00
51016000029	50	50	95	310,00
99020140054	60	55	150	560,00

SİLİNDİRİK ORTA TENCERE KAPAKLI
CYLINDRICAL STEW POT MIDDLE WITH LID



KOD Code (Mat - Satin)	ÇAP Diameter (cm)	YÜKSEKLİK Height (cm)	KAPASİTE Capacity (Lt.)	FİYAT PRICE €
51016000001	16	11	2,1	30,00
51016000035	18	12	3	32,00
51016000006	20	13	4	34,00
51016000010	24	15	6,6	46,00
51016000014	28	17	10	53,00
51016000033	30	20	13,9	57,00
51016000017	32	20	16	71,00
51016000019	35	22	21	95,00
51016000022	40	25	30	119,00
51016000025	45	28	43	150,00
51016000028	50	30	57	205,00
51016000031	65	35	110	342,00

SİLİNDİRİK SİĞ TENCERE KAPAKLI
CYLINDRICAL STEW POT SHALLOW WITH LID



KOD Code (Mat - Satin)	ÇAP Diameter (cm)	YÜKSEKLİK Height (cm)	KAPASİTE Capacity (Lt.)	FİYAT PRICE €
51016000003	16	8	1,6	28,00
51016000005	18	9	2,2	32,00
51016000008	20	9	2,7	35,00
51016000009	24	10	4,4	45,00
51016000013	28	12	7,2	52,00
51016000036	30	15	10,4	60,00
51016000016	32	15	12	69,00
51016000032	35	17	16	85,00
51016000021	40	20	24	114,00
51016000024	45	22	34	140,00
51016000027	50	20	38	189,00
51016000030	65	25	80	319,00

KAPAKLI KARNİYARİK TENCERE / BRAZIER WITH LID

KOD CODE (MAT/SATIN)	ÇAP DIAMETER (cm)	YÜKSEKLİK HEIGHT (cm)	KAPASİTE Capacity (Lt.)	FİYAT PRICE €
51013000001	32	8	6,4	65,00
51013000002	35	8	8	80,00
51013000003	40	10	10	100,00
51013000004	45	10	16	135,00
51013000005	50	10	20	160,00



TABANSIZ KAÇAROLA / CASSEROLE WITHOUT SANDWICH BOTTOM

KOD CODE (MAT/SATIN)	ÇAP DIAMETER (cm)	YÜKSEKLİK HEIGHT (cm)	KAPASİTE Capacity (Lt.)	FİYAT PRICE €
52004000001	16	11	2,2	15,00
52004000002	18	12	3	17,00
52004000003	20	13	4	19,00
52004000004	24	15	6,7	25,00
52004000005	28	17	10,00	34,00



TABANLI KAÇAROLA / CASSEROLE WITH SANDWICH BOTTOM

KOD CODE (MAT/SATIN)	MODEL Model	YÜKSEKLİK HEIGHT (cm)	KAPASİTE Capacity (Lt.)	FİYAT PRICE €
52001000002	SİĞ	Ø16 x 7	1,4	19,00
52001000004	SİĞ	Ø18 x 8	2	22,00
52001000006	SİĞ	Ø20 x 9	2,8	25,00
52001000007	SİĞ	Ø24 x 10	4,5	31,00
52001000009	SİĞ	Ø28 x 12	7,3	42,00
52001000001	DERİN	Ø16 x 11	2,2	20,00
52001000003	DERİN	Ø18 x 12	3	22,00
52001000005	DERİN	Ø20 x 13	4	24,00
52001000008	DERİN	Ø24 x 15	6,7	37,00
52001000010	DERİN	Ø28 x 17	10,4	47,00



TEK SAPLI KIZARTMA TAVASI / FRYINGPAN WITH SINGLE HANDLE

KOD CODE (MAT/SATIN)	ÇAP Diameter (cm)	YÜKSEKLİK HEIGHT (cm)	KAPASİTE Capacity (Lt.)	FİYAT PRICE €
52009000001	20	4	1,5	21,00
52009000002	24	5	2	23,00
52009000003	26	5	2,9	28,00
52009000004	28	6	3,6	35,00
52009000005	32	6	4,8	42,00
52009000006	35	8	10	57,00
52009000007	40	8	12	70,00



SOTE TAVA PASLANMAZ ÇELİK S/S SLAUTE PAN

KOD CODE (MAT/SATIN)	ÇAP Diameter (cm)	YÜKSEKLİK HEIGHT (cm)	KAPASİTE Capacity (Lt.)	FİYAT PRICE €
52012000001	16	6	1	18,00
52012000002	18	6	1,2	19,00
52012000003	20	6,5	1,6	21,00
52012000004	24	7,5	2,7	25,00



YAPIŞMAZ KIZARTMA TAVASI NON-STICK FRYINGPAN WITH SINGLE HANDLE

KOD Code	ÇAP Diameter (cm)	YÜKSEKLİK HEIGHT (cm)	KAPASİTE Capacity (Lt.)	FİYAT PRICE €
52011000003	20	4	1,5	38,00
52011000004	24	5	2	45,00
52011000005	26	5	2,9	50,00
52011000006	28	6	3,6	56,00
52011000007	32	6	4,8	65,00
52011000001	35	8	10	88,00
52011000002	40	8	12	105,00



TEFLON TAVA (ALÜMİNYUM) TEFLON FRYINGPAN (ALUMINIUM)

KOD Code	ÇAP Diameter (cm)	KAPASİTE Capacity (Lt.)	FİYAT PRICE €
99020130063	18	4	23,00
99020130064	20	4	29,00
99020130065	22	4	31,00
99020130066	24	5	34,00
99020130067	26	5	35,00
99020130068	28	5,5	36,00
99020130069	30	5,5	37,00
99020130070	32	6	40,00
99020130071	35	7	47,00
99020130072	40	8	55,00



TEFLON WOK TAVASI (ALÜMİNYUM) TEFLON WOK PAN (ALUMINIUM)

KOD Code	ÇAP Diameter (cm)	YÜKSEKLİK HEIGHT (cm)	FİYAT PRICE €
99020130055	24	9	23,00
99020130056	26	9	30,00
99020130057	28	9	31,00
99020130058	30	11	34,00
99020130059	32	11	40,00
99020130060	36	13	50,00



TEFLON KREP TAVASI (ALÜMİNYUM) TEFLON CREPE PAN (ALUMINIUM)

KOD Code	ÇAP Diameter (cm)	FİYAT PRICE €
99020130035	Ø16	17,00
99020130036	Ø18	19,00
99020130037	Ø20	22,00
99020130038	Ø22	23,00
99020130039	Ø24	26,00
99020130040	Ø26	28,00
99020130041	Ø28	30,00
99020130042	Ø30	33,00
99020130043	Ø32	35,00





İZOLASYONLU YEMEK TAŞIMA KABI
ISOLATED CARRYING CONTAINER

KOD Code	MODEL Model	ÇAP Diameter (cm)	YÜKSEKLİK Height (cm)	KAPASİTE Capacity (Lt.)	FİYAT PRICE €
53003000007	ÇİFT CİDARLI - DOUBLE WALL	Ø32	10	5	143,00
53003000001	ÇİFT CİDARLI - DOUBLE WALL	Ø32	17	10	155,00
53003000002	ÇİFT CİDARLI - DOUBLE WALL	Ø32	25	15	161,00
53003000003	ÇİFT CİDARLI - DOUBLE WALL	Ø32	30	20	180,00
53003000005	ÇİFT CİDARLI - DOUBLE WALL	Ø35	35	28	198,00
53003000006	ÇİFT CİDARLI - DOUBLE WALL	Ø40	40	42	239,00

YEMEK TAŞIMA KABI
CARRYING CONTAINER



KOD Code	MODEL Model	ÇAP Diameter (cm)	YÜKSEKLİK Height (cm)	KAPASİTE Capacity (Lt.)	FİYAT PRICE €
53004000007	TABANLI - WITH BOTTOM	24	24	11	83,00
53005000007	TABANSIZ - WITHOUT BOTTOM	24	24	11	65,00
53004000001	TABANLI - WITH BOTTOM	30	28	19	90,00
53005000001	TABANSIZ - WITHOUT BOTTOM	30	28	19	71,00
53004000002	TABANLI - WITH BOTTOM	30	32	22	98,00
53005000002	TABANSIZ - WITHOUT BOTTOM	30	32	22	78,00
53004000003	TABANLI - WITH BOTTOM	35	35	33	125,00
53005000003	TABANSIZ - WITHOUT BOTTOM	35	35	33	101,00
53004000004	TABANLI - WITH BOTTOM	40	40	48	143,00
53005000004	TABANSIZ - WITHOUT BOTTOM	40	40	48	121,00
53004000005	TABANLI - WITH BOTTOM	45	45	70	211,00
53005000005	TABANSIZ - WITHOUT BOTTOM	45	45	70	153,00
53004000006	TABANLI - WITH BOTTOM	50	50	95	276,00
53005000006	TABANSIZ - WITHOUT BOTTOM	50	50	95	230,00



PASLANMAZ ÇELİK PATİSERİ FIRIN TEPSİSİ KAPAKSIZ
STAINLESS STEEL PATISSERIE OVEN TRAY WITHOUT LID

KOD Code	MODEL	EBAT Size (cm)	KAPASİTE Capacity (Lt.)	FİYAT PRICE €
55017000001	Paslanmaz Çelik / S/S	40 x 60 x 2,5	6	36,00
55017000002	Paslanmaz Çelik / S/S	40 x 60 x 6	14,4	38,00
55017010001	Yapışmaz / Non-Stick	40 x 60 x 2,5	6	55,00
55017010003	Yapışmaz / Non-Stick	40 x 60 x 6	14,4	65,00



KLİPSLİ - KULPLU FIRIN TEPSİSİ KAPAKLI
OVEN TRAY WITH LOCK - HANDLE WITH LID

KOD Code	EBAT Size (cm)	KAPASİTE Capacity (Lt.)	FİYAT PRICE €
55008000003	35 x 45 x 8	11	67,00
55008000002	40 x 60 x 8	19,2	86,00
55008000004	45 x 60 x 8	21	90,00
55008000005	50 x 70 x 8	28	115,00
55008000006	50 x 70 x 10	35	132,00

FIRIN TEPSİSİ KAPAKSIZ / OVEN TRAY WITHOUT LID

KOD Code	EBAT Size (cm)	KAPASİTE Capacity (Lt.)	FİYAT PRICE €
55007000001	35 x 45 x 5	6,3	30,00
55007000002	35 x 45 x 8	11	33,00
55007000003	40 x 60 x 5	12	41,00
55007000004	40 x 60 x 8	19,2	46,00
55007000005	45 x 60 x 5	13,5	44,00
55007000006	45 x 60 x 8	21	49,00
55007000008	50 x 70 x 5	14	58,00
55007000009	50 x 70 x 8	28	63,00
55007000007	50 x 70 x 10	35	72,00
55007000010	60 x 80 x 2	9,6	219,00



TEFLONLU FIRIN TEPSİSİ KAPAKSIZ
NON STICK TEFLON TRAY WITHOUT LID

KOD Code	EBAT Size (cm)	KAPASİTE Capacity (Lt.)	FİYAT PRICE €
55011000001	35 x 45 x 5	6,3	43,00
55011000002	35 x 45 x 8	11	50,00
55011000004	40 x 60 x 5	13,5	60,00
55011000006	40 x 60 x 8	21	68,00
55011000008	45 x 60 x 5	13,5	65,00
55011000009	45 x 60 x 8	21	72,00
55011000011	50 x 70 x 5	14	82,00
55011000012	50 x 70 x 8	28	97,00
55011000010	50 x 70 x 10	35	118,00



FIRIN TEPSİ KAPAĞI / LID FOR OVEN TRAY

KOD Code	EBAT Size (cm)	FİYAT PRICE €
55002000001	35 x 45	20,00
55002000002	40 x 60	27,00
55002000003	45 x 60	29,00
55002000004	50 x 70	35,00





KUSKUS TENCERESİ
COUSCOUS STOC POT

KOD Code	MODEL Model	ÇAP Diameter (cm)	DERİNLİK Height (cm)	FİYAT PRICE €
51015000002	Set Kapaklı / Set With Lid	35 x 35 (a)	50 x 20 (b)	210,00
51015000003	Set Kapaklı / Set With Lid	40 x 40 (a)	55 x 20 (b)	255,00
51015000004	Set Kapaklı / Set With Lid	45 x 45 (a)	60 x 20 (b)	332,00
51015000005	Set Kapaklı / Set With Lid	50 x 50 (a)	65 x 25 (b)	433,00
51015000201	Kuskus Süzgeci / Cous Cous Strainer	Ø50	20	96,00
51015000202	Kuskus Süzgeci / Cous Cous Strainer	Ø55	20	123,00
51015000203	Kuskus Süzgeci / Cous Cous Strainer	Ø60	20	157,00
51015000204	Kuskus Süzgeci / Cous Cous Strainer	Ø65	25	192,00



SİLİNDİRİK TENCERE MUSLUKLU TABANLI KAPAKLI
STEW POT WITH TAP WITH BOTTOM WITH LID

KOD Code	ÇAP Diameter (cm)	KAPASİTE Capacity (Lt.)	FİYAT PRICE €
51022000101	Ø 32 x 32	17	130,00
51022000102	Ø 35 x 35	35	152,00
51022000103	Ø 40 x 40	48	195,00
51022000104	Ø 45 x 45	70	230,00
51022000105	Ø 50 x 50	95	260,00



SEFER TASI PASLANMAZ ÇELİK
MULTI COMP. CARRYING CONTAINER STAINLESS STEEL

KOD Code 304 Kalite	FİYAT PRICE €	KOD Code 430 Kalite	FİYAT PRICE €	ÇAP Diameter (cm)	KAPASİTE Capacity (Lt.)	BÖLÜM Compartment
99090010010	37,00	99090010009	23,00	16	3 x 1,4 = 4,2	3
99090010012	47,00	99090010011	27,00	16	4 x 1,4 = 5,6	4
99090010015	43,00	99090010014	27,00	18	3 x 2 = 6	3
99090010017	56,00	99090010016	32,00	18	4 x 2 = 8	4
99090010020	49,00	99090010019	30,00	20	3 x 3,1 = 9,3	3
99090010022	65,00	99090010021	34,00	20	4 x 3,1 = 12,4	4
99090010025	60,00	99090010024	33,00	22	3 x 4,8 = 14,4	3
99090010027	75,00	99090010026	42,00	22	4 x 4,8 = 19,2	4
99090010030	69,00	99090010029	40,00	24	3 x 6,3 = 18,9	3
99090010032	91,00	99090010031	48,00	24	4 x 6,3 = 25,2	4
99090010034	81,00	99090010037	42,00	26	3 x 7,4 = 22,2	3
99090010036	104,00	99090010035	53,00	26	4 x 7,4 = 29,6	4
99090010040	97,00	99090010039	49,00	28	3 x 8 = 24	3
99090010042	113,00	99090010041	62,00	28	4 x 8 = 32	4
99090010044	75,00	99090010043	40,00	30	2 x 9,8 = 29,4	2
99090010046	93,00	99090010045	55,00	30	3 x 9,8 = 39,2	3
99090010048	126,00	99090010047	72,00	30	4x9,8=39,2	4



MAKARNA SÜZGEÇİ
PASTA STRAINER

KOD Code	MODEL Model	ÇAP Diameter (cm)	YÜKSEKLİK Height	FİYAT PRICE €
51006000013	Tekli / Single	Ø 36	22	71,00
51006000014	Tekli / Single	Ø 40	26	75,00



HELVANE TENCERE KAPAĞI / WIDE POT LID

KOD Code (Parlak)	MODEL	ÇAP (cm)	FİYAT PRICE €
51001000003	HELVANE	30	15,00
51001000004	HELVANE	36	18,00
51001000005	HELVANE	40	24,00
51001000006	HELVANE	45	28,00
51001000007	HELVANE	50	39,00
51001000008	HELVANE	55	44,00
51001000009	HELVANE	60	52,00
51001000010	HELVANE	65	57,00
51001000011	HELVANE	70	60,00
51001000012	HELVANE	80	80,00
51001000013	HELVANE	90	90,00
51001000001	HELVANE	100	110,00
51001000002	HELVANE	110	125,00



SİLİNDİRİK TENCERE KAPAĞI
STEW POT LID

KOD Code (Mat)	MODEL	ÇAP (cm)	FİYAT PRICE €
51002000002	SİLİNDİRİK	16	6,00
51002000003	SİLİNDİRİK	18	6,00
51002000004	SİLİNDİRİK	20	7,00
51002000005	SİLİNDİRİK	24	8,00
51002000006	SİLİNDİRİK	28	11,00
51002000007	SİLİNDİRİK	30	15,00
51002000008	SİLİNDİRİK	32	16,00
51002000009	SİLİNDİRİK	35	18,00
51002000010	SİLİNDİRİK	40	23,00
51002000011	SİLİNDİRİK	45	27,00
51002000012	SİLİNDİRİK	50	32,00
51002000013	SİLİNDİRİK	60	47,00



ÇORBALIK KAPAKLI - KULPSUZ
POT, WITH LID WITHOUT HANDLE

KOD Code	MODEL	ÇAP (cm)	YÜKSEKLİK (cm)	KAPASİTE Capacity (Lt.)	FİYAT PRICE €
51007000001	TABANLI	Ø 24	24	10,5	48,00
51009000001	TABANSIZ	Ø 24	24	10,5	34,00
51007000002	TABANLI	Ø 28	28	17,2	68,00
51009000002	TABANSIZ	Ø 28	28	17,2	44,00
51007000003	TABANLI	Ø 30	28	19,8	73,00
51009000003	TABANSIZ	Ø 30	28	19,8	60,00
51007000004	TABANLI	Ø 30	32	22,6	77,00
51009000004	TABANSIZ	Ø 30	32	22,6	64,00
51007000005	TABANLI	Ø 32	32	25,7	90,00
51009000005	TABANSIZ	Ø 32	32	25,7	68,00
51007000006	TABANLI	Ø 35	35	33,6	107,00
51009000006	TABANSIZ	Ø 35	35	33,6	87,00
51007000007	TABANLI	Ø 40	40	50,2	131,00
51009000007	TABANSIZ	Ø 40	40	50,2	106,00
51007000008	TABANLI	Ø 45	45	71,5	183,00
51009000008	TABANSIZ	Ø 45	45	71,5	154,00
51007000009	TABANLI	Ø 50	50	98,1	200,00
51009000009	TABANSIZ	Ø 50	50	98,1	160,00

GASTRONORM KÜVETLER
GASTRONORM CONTAINER

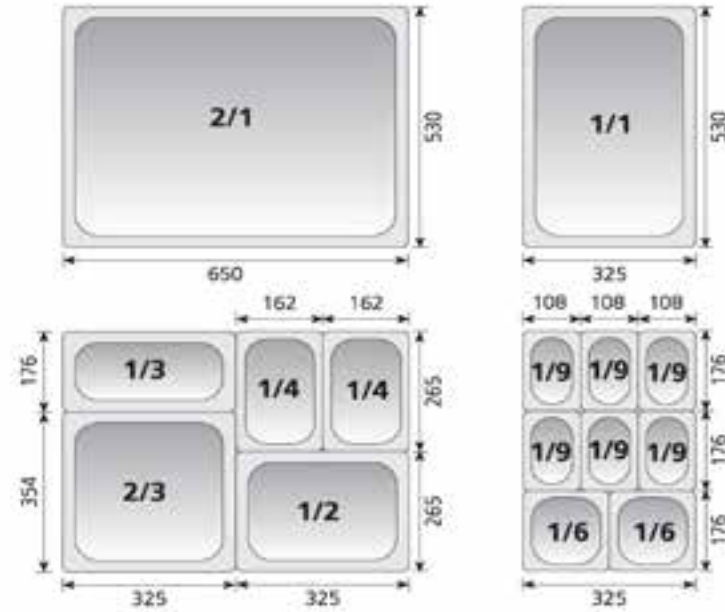

2/1

KOD Code	ÇAP Diameter (mm)	YÜKSEKLİK Height (mm)	KAPASİTE Capacity (Lt.)	FİYAT PRICE €
55014000002	650 x 530	10	TRAY	28,00
54004000030	650 x 530	20	TRAY	30,00
54004000032	650 x 530	40	12	34,00
54004000033	650 x 530	65	19	38,00
54004000028	650 x 530	100	29	46,00
54004000029	650 x 530	150	43	65,00
54004000031	650 x 530	200	57	77,00



1/1

KOD Code	ÇAP Diameter (mm)	YÜKSEKLİK Height (mm)	KAPASİTE Capacity (Lt.)	FİYAT PRICE €
55014000001	530 x 325	10	TRAY	14,00
54004000001	530 x 325	20	TRAY	14,00
54004000045	530 x 325	40	5,4	15,00
54004000046	530 x 325	65	8,7	18,00
54004000047	530 x 325	100	13	24,00
54004000048	530 x 325	150	20	32,00
54004000002	530 x 325	200	26	37,00



2/3

KOD Code	ÇAP Diameter (mm)	YÜKSEKLİK Height (mm)	KAPASİTE Capacity (Lt.)	FİYAT PRICE €
54004000035	354 x 325	20	TRAY	10,00
54004000037	354 x 325	40	3,4	13,00
54004000038	354 x 325	65	5,5	14,00
54004000034	354 x 325	100	8,4	18,00
54004000049	354 x 325	150	12	26,00
54004000036	354 x 325	200	16	30,00



1/2

KOD Code	ÇAP Diameter (mm)	YÜKSEKLİK Height (mm)	KAPASİTE Capacity (Lt.)	FİYAT PRICE €
54004000006	325 x 265	20	TRAY	9,00
54004000008	325 x 265	40	2,4	10,00
54004000009	325 x 265	65	3,8	11,00
54004000004	325 x 265	100	5,9	16,00
54004000005	325 x 265	150	8,7	20,00
54004000007	325 x 265	200	11	24,00



1/3

KOD Code	ÇAP Diameter (mm)	YÜKSEKLİK Height (mm)	KAPASİTE Capacity (Lt.)	FİYAT PRICE €
54004000012	325 x 176	20	TRAY	8,00
54004000014	325 x 176	40	1,5	9,00
54004000015	325 x 176	65	2,5	10,00
54004000010	325 x 176	100	3,8	12,00
54004000011	325 x 176	150	5,5	17,00
54004000013	325 x 176	200	7	24,00



1/4

KOD Code	ÇAP Diameter (mm)	YÜKSEKLİK Height (mm)	KAPASİTE Capacity (Lt.)	FİYAT PRICE €
54004000019	265 x 162	20	TRAY	8,00
54004000016	265 x 162	40	1,2	9,00
54004000021	265 x 162	65	1,7	11,00
54004000017	265 x 162	100	2,7	13,00
54004000018	265 x 162	150	3,8	15,00
54004000020	265 x 162	200	4,8	23,00



1/6

KOD Code	ÇAP Diameter (mm)	YÜKSEKLİK Height (mm)	KAPASİTE Capacity (Lt.)	FİYAT PRICE €
54004000025	176 x 162	65	1	8,00
54004000022	176 x 162	100	1,6	10,00
54004000023	176 x 162	150	2,2	16,00
54004000024	176 x 162	200	2,8	19,00



1/9

KOD Code	ÇAP Diameter (mm)	YÜKSEKLİK Height (mm)	KAPASİTE Capacity (Lt.)	FİYAT PRICE €
54004000027	176 x 108	65	0,6	8,00
54004000026	176 x 108	100	0,9	9,00



2/4

KOD Code	ÇAP Diameter (mm)	YÜKSEKLİK Height (mm)	KAPASİTE Capacity (Lt.)	FİYAT PRICE €
54004000041	530 x 162	20	TRAY	11,00
54004000043	530 x 162	40	2,7	12,00
54004000044	530 x 162	65	4,3	13,00
54004000039	530 x 162	100	6,5	19,00
54004000040	530 x 162	150	10	24,00

DELİKLİ GASTRONORM KÜVETLER
PERFORATED GASTRONORM CONTAINERS



2/1	KOD Code	ÇAP Diameter (mm)	YÜKSEKLİK Height (mm)	FİYAT PRICE €
	54006000034	650 x 530	20	34,00
	54006000036	650 x 530	40	36,00
	54006000037	650 x 530	65	43,00
	54006000032	650 x 530	100	49,00
	54006000033	650 x 530	150	75,00
	54006000035	650 x 530	200	90,00



1/1	KOD Code	ÇAP Diameter (mm)	YÜKSEKLİK Height (mm)	FİYAT PRICE €
	54006000004	530 x 325	20	17,00
	54006000006	530 x 325	40	20,00
	54006000007	530 x 325	65	21,00
	54006000002	530 x 325	100	26,00
	54006000003	530 x 325	150	36,00
	54006000005	530 x 325	200	49,00



2/3	KOD Code	ÇAP Diameter (mm)	YÜKSEKLİK Height (mm)	FİYAT PRICE €
	54006000040	354 x 325	20	14,00
	54006000042	354 x 325	40	16,00
	54006000043	354 x 325	65	18,00
	54006000038	354 x 325	100	21,00
	54006000039	354 x 325	150	33,00
	54006000041	354 x 325	200	38,00



1/2	KOD Code	ÇAP Diameter (mm)	YÜKSEKLİK Height (mm)	FİYAT PRICE €
	54006000011	325 x 265	20	12,00
	54006000013	325 x 265	40	13,00
	54006000014	325 x 265	65	14,00
	54006000009	325 x 265	100	16,00
	54006000010	325 x 265	150	23,00
	54006000012	325 x 265	200	33,00



1/3	KOD Code	ÇAP Diameter (mm)	YÜKSEKLİK Height (mm)	FİYAT PRICE €
	54006000018	325 x 176	20	9,00
	54006000020	325 x 176	40	10,00
	54006000021	325 x 176	65	12,00
	54006000016	325 x 176	100	16,00
	54006000017	325 x 176	150	22,00
	54006000019	325 x 176	200	27,00



1/4	KOD Code	ÇAP Diameter (mm)	YÜKSEKLİK Height (mm)	FİYAT PRICE €
	99010030064	265 x 162	20	8,00
	99010030066	265 x 162	40	10,00
	99010030067	265 x 162	65	11,00
	99010030062	265 x 162	100	13,00
	99010030063	265 x 162	150	20,00
	99010030065	265 x 162	200	27,00



DONDURMA KÜVETİ
GN CONTAINER FOR ICE CREAM

KOD Code	ÇAP Diameter (mm)	YÜKSEKLİK Height (mm)	KAPASİTE Capacity (Lt.)	FİYAT PRICE €
54003000001	365 x 174	120	4	18,00
54003000002	365 x 174	150	6	20,00

GASTRONORM TEPSİ
GN TRAY



KOD Code	DIŞ EBAT Size (mm)	YÜKSEKLİK Height (mm)	FİYAT PRICE €
55001000001	530 x 325	1/1 20	15,00
55001000002	530 x 325	1/1 40	18,00
55001000003	530 x 325	1/1 65	20,00
55001000004	325 x 265	1/2 20	9,00
55001000005	325 x 265	1/2 40	10,00
55001000006	325 x 265	1/2 65	11,00
55001000007	650 x 530	2/1 20	30,00
55001000008	650 x 530	2/1 40	34,00
55001000009	650 x 530	2/1 65	39,00
55001000010	354 x 325	2/3 20	11,00
55001000011	354 x 325	2/3 40	14,00
55001000012	354 x 325	2/3 65	16,00



ÇİFT SAPLI GASTRONORM KÜVETLER
GASTRONORM CONTAINER WITH DOUBLE HANDLE

2/1	KOD Code	ÇAP Diameter (mm)	YÜKSEKLİK Height (mm)	KAPASİTE Capacity (Lt.)	FİYAT PRICE €
	54005000026	650 x 530	65	19	36,00
	54005000024	650 x 530	100	29	42,00
	54005000001	650 x 530	150	43	57,00
	54005000025	650 x 530	200	57	74,00



1/1	KOD Code	ÇAP Diameter (mm)	YÜKSEKLİK Height (mm)	KAPASİTE Capacity (Lt.)	FİYAT PRICE €
	54005000005	530 x 325	65	8,7	22,00
	54005000002	530 x 325	100	13	25,00
	54005000003	530 x 325	150	20	32,00
	54005000004	530 x 325	200	26	42,00



2/3	KOD Code	ÇAP Diameter (mm)	YÜKSEKLİK Height (mm)	KAPASİTE Capacity (Lt.)	FİYAT PRICE €
	54005000030	354 x 325	65	5,5	19,00
	54005000027	354 x 325	100	8,4	24,00
	54005000028	354 x 325	150	12	32,00
	54005000029	354 x 325	200	16	37,00



1/2	KOD Code	ÇAP Diameter (mm)	YÜKSEKLİK Height (mm)	KAPASİTE Capacity (Lt.)	FİYAT PRICE €
	54005000009	325 x 265	65	3,8	16,00
	54005000006	325 x 265	100	5,9	19,00
	54005000007	325 x 265	150	8,7	25,00
	54005000008	325 x 265	200	11	32,00



1/3	KOD Code	ÇAP Diameter (mm)	YÜKSEKLİK Height (mm)	KAPASİTE Capacity (Lt.)	FİYAT PRICE €
	54005000013	325 x 176	65	2,5	14,00
	54005000010	325 x 176	100	3,8	17,00
	54005000011	325 x 176	150	5,5	24,00
	54005000012	325 x 176	200	7	29,00



1/4	KOD Code	ÇAP Diameter (mm)	YÜKSEKLİK Height (mm)	KAPASİTE Capacity (Lt.)	FİYAT PRICE €
	54005000017	265 x 162	65	1,8	13,00
	54005000014	265 x 162	100	2,7	15,00
	54005000015	265 x 162	150	3,8	22,00
	54005000016	265 x 162	200	4,8	25,00

1/6	KOD Code	ÇAP Diameter (mm)	YÜKSEKLİK Height (mm)	KAPASİTE Capacity (Lt.)	FİYAT PRICE €
	54005000021	176 x 162	65	1	11,00
	54005000018	176 x 162	100	1,6	13,00
	54005000019	176 x 162	150	2,2	17,00
	54005000020	176 x 162	200	2,8	21,00



GASTRONORM KÜVET KAPAĞI
GN CONTAINER LID

KOD Code	EBAT Size	FİYAT PRICE €
54013000007	GN 2/1	27,00
54013000008	GN 1/1	14,00
54013000009	GN 2/3	11,00
54013000002	GN 1/2	9,00
54013000003	GN 1/3	8,00
54013000004	GN 1/4	6,00
54013000005	GN 1/6	5,00
54013000006	GN 1/9	5,00
54013000001	GN 2/4	10,00



KEPÇE DELİKLİ GN KÜVET KAPAĞI
GN CONTAINER LID SLOTTED FOR LADLE

KOD Code	MODEL	EBAT Size (mm)	FİYAT PRICE €
54012000001	1/1	530 x 325	14,00
54012000002	1/2	325 x 265	10,00
54012000003	1/3	325 x 176	8,00
54012000004	1/4	265 x 162	7,00
54012000005	1/6	176 x 162	6,00
54012000006	2/4	530 x 170	11,00



GN ÇİFT SAP DELİKLİ KÜVET KAPAĞI
GN CONTAINER LID WITH DOUBLE HANDLE

KOD Code	MODEL	EBAT Size (mm)	FİYAT PRICE €
54011000007	2/1	530 x 650	29,00
54011000001	1/1	530 x 325	14,00
54011000008	2/3	354 x 325	11,00
54011000002	1/2	325 x 265	10,00
54011000003	1/3	325 x 176	8,00
54011000004	1/4	265 x 162	7,00
54011000005	1/6	176 x 162	6,00



SİLİKONLU GASTRONORM KÜVET KAPAĞI
GN CONTAINER LID WITH SILICON FRAME

KOD Code	EBAT Size (mm)	FİYAT PRICE €
54010000006	GN 2/1	58,00
54010000001	GN 1/1	29,00
54010000002	GN 1/2	20,00
54010000003	GN 1/3	18,00
54010000004	GN 1/4	15,00
54010000005	GN 1/6	14,00
54010000007	GN 2/3	23,00



GN SÜZGEÇ / GN STRAINER

KOD Code	MODEL	FİYAT PRICE €
5401500001	1/1 - h15 mm	23,00
5401500002	1/2 - h15 mm	17,00
5401500003	1/3 - h15 mm	14,00
5401500004	2/1 - h15 mm	41,00



GLASO TELİ / (PASLANMAZ TEL IZGARA) STAINLESS STEEL GRID

KOD Code	EBAT Size (mm)	FİYAT PRICE €
99010010002	1/1 530 x 325	23,00
99010010004	1/2 325 x 265	15,00
99010010006	2/1 650 x 530	37,00
99010010011	400 x 600	29,00
99010010008	2/3 354 x 325	18,00



GN ÇUBUK / GN BAR

KOD Code	EBAT Dimen.sion (cm)	UZUNLUK Length (cm)	FİYAT PRICE €
54002000004	1/1 EBAT / Size	53	4,00
54002000003	1/2 EBAT / Size	32,5	4,00
54002000002	1/3 EBAT / Size	17,6	3,00
54002000001	1/4 EBAT / Size	16,2	3,00



REYON TEPSİSİ / RAYON TRAY

KOD Code	EBAT Size (mm)	FİYAT PRICE €
55016000001	250 x 400*20	26,00
55016000002	250 x 400*40	30,00
55016000003	250 x 800*20	40,00
55016000004	250 x 800*40	44,00



LOKANTA TEPSİSİ / RESTAURANT TRAY

KOD Code	EBAT Size (mm)	FİYAT PRICE €
55014000003	300 x 500 x 1,5	15,00
55014000004	350 x 450 x 1,5	16,00
55014000005	450 x 600 x 1,5	23,00
55014000006	500 x 700 x 1,5	27,00



PASTACI TEPSİSİ / PASTRY TRAY

KOD Code	EBAT Size (mm)	FİYAT PRICE €
55015000001	100 x 300	5,00
55015000002	150 x 300	6,00
55015000003	200 x 300	7,00
55015000004	250 x 400	10,00
55015000005	300 x 500	15,00



SELF SERVİS TEPSİSİ / SELF SERVICE TRAY

KOD Code	EBAT Size (mm)	FİYAT PRICE €
55003000002	28 x 40 x 0,60	10,00
55003000003	28 x 40*0,70	11,00
55003000004	28 x 40*0,80	12,00
55003000005	28 x 40*1,00	14,00



MAYONEZ KABI / MIXING BOWL

KOD Code	EBAT Size (cm)	KAPASİTE Capacity (Lt.)	FİYAT PRICE €
99020140008	Ø24 x 12	4,5	20,00
99020140009	Ø26 x 15	8	23,00
99020140010	Ø30 x 17	12	27,00
99020140011	Ø36 x 21	22	35,00



TABAK KAPAĞI / COVER PLATE

KOD Code	MODEL	EBAT Size (Cm)	FİYAT PRICE €
55004000001	DELİKLİ	Ø 27,5	12,00
55005000001	KULPLU	Ø 27,5	13,00
55004000002	DELİKLİ	Ø 28,5	13,00
55004000005	DELİKLİ	Ø 29,5	14,00
55005000003	KULPLU	Ø 29,5	15,00
55004000004	KULPLU	Ø 32,0	17,00



**TEK VE ÇİFT SEPETİ FRİTÖZ
SINGLE AND DOUBLE BASKET FRYER**

KOD Code	EBAT Size (mm)	GERİLİM Energy	KAPASİTE Capacity (Lt.)	GÜÇ Power (kW)	FİYAT PRICE €
802130112	175 x 415 x 300	230V	5	3	125,00
802230132	270 x 415 x 300	230V	8	3	150,00
802430142	370 x 415 x 300	230V	5+5	3 x 2	220,00
802530142	555 x 415 x 300	230V	8+8	3 x 2	240,00



**BIÇAK STERİLİZASYON DOLABI
KNIVES STERILIZATION CUPBOARD**

KOD Code	KAPASİTE Capacity (Bıçak) (Knives)	GÜÇ Power (kW)	AĞIRLIK Weight (kg)	EBAT Size (cm)	FİYAT PRICE €
502431102	10	0,15	7	50 x 10 x 60	242,00
502931102	20	0,30	12	100 x 10 x 60	336,00



**ÇAY MAKİNESİ
TEA MAKER**

KOD Code	HACİM Volume (lt)	KAPASİTE Capacity (Bardak)	ÇALIŞMA ISISI Operating Temperature (kg/h)	VOLTAJ Voltage (V)	GÜÇ Power (kw)	FİYAT PRICE €
58001000007	5	50	85	220	0,9	110,00
58001000011	7	70	85	220	1,2	116,00
58001000013	9	90	85	220	1,5	121,00
58001000001	13	130	85	220	1,5	138,00
58001000002	17	170	85	220	2	149,00
58001000004	23	230	85	220	2	187,00
58001000005	35	350	85	220	3	253,00
58001000009	50	500	85	220	4	270,00

- Paslanmaz çelik gövdeli
- Termostat kontrollüdür
- İthal rezistanslıdır
- Gömme tip rezistans kullanılmaktadır.
- Monoblok özel çelik musluklu
- Stainless steel body
- Thermostat controlled
- Importing resistance
- Built in resistance
- Monoblock steel tap
- Monoblock pool



**SU ISITICI
HOT WATER DISPENSER**

KOD Code	HACİM Volume (lt)	KAPASİTE Capacity (Bardak)	ÇALIŞMA ISISI Operating Temperature (kg/h)	VOLTAJ Voltage (V)	GÜÇ Power (kw)	FİYAT PRICE €
58003000005	5	50	85	220	0,9	77,00
58003000007	7	70	85	220	1,2	83,00
58003000009	9	90	85	220	1,5	88,00
58003000001	13	130	85	220	1,5	94,00
58003000002	17	170	85	220	2	105,00
58003000003	23	230	85	220	2	143,00
58003000004	35	350	85	220	3	182,00
58003000006	50	500	85	380	4,5	237,00



**FİLTRE KAHVE MAKİNESİ
FILTER COFFEE MACHINE**

KOD Code	HACİM Volume (lt)	KAPASİTE Capacity (Bardak)	VOLTAJ Voltage (V)	GÜÇ Power (kw)	FİYAT PRICE €
58002000001	13	100	220	1,64	180,00
58002000002	23	200	220	2,2	220,00

Not

Servis Ekipmanları

Service Equipments



www.kayalarmutfak.com.tr

444 5 957





180° AÇILIR KAPAKLI REŞO
CHAFING DISH WITH 180° ROLL TOP LID

KOD Code	MODEL Model	ISITMA TİPİ Heated Type	EBAT Size (mm)	GN KAPASİTE Capacity GN (Lt.)	FİYAT PRICE €
59002000003	STANDART	ELEKTRİKLİ	670 x 490 x 440	GN 1/1-65	485,00
59002000006	STANDART	JEL / GEL	670 x 490 x 440	GN 1/1-65	400,00



ANKASTRE 180° AÇILIR KAPAKLI YUVARLAK
CHAFING DISH WITH 180° ROLL TOP LID BUILD IN

KOD Code	MODEL Model	ISITMA TİPİ Heated Type	EBAT Size (mm)	GN KAPASİTE Capacity GN (Lt.)	FİYAT PRICE €
59002000004	ANKASTRE	ELEKTRİKLİ	670 x 490 x 440	GN 1/1-65	430,00



180° AÇILIR KAPAKLI REŞO ÇORBALIK
CHAFING DISH WITH 180° ROLL TOP LID FOR 2 SOUP BOWLS

KOD Code	MODEL Model	ISITMA TİPİ Heated Type	EBAT Size (mm)	GN KAPASİTE Capacity GN (Lt.)	FİYAT PRICE €
59002000001	2' Lİ ÇORBALIK	ELEKTRİKLİ	670 x 490 x 440	5,5 + 5,5 lt	530,00
59002000002	2' Lİ ÇORBALIK	JEL / GEL	670 x 490 x 440	5,5 + 5,5 lt	485,00



ANKASTRE 180° AÇILIR KAPAKLI CHAFING DISH ÇORBALIK
CHAFING DISH WITH 180° ROLL TOP LID FOR 2 BUILD IN

KOD Code	MODEL Model	ISITMA TİPİ Heated Type	EBAT Size (mm)	GN KAPASİTE Capacity GN (Lt.)	FİYAT PRICE €
59002000019	ANKASTRE / Built In	ELEKTRİKLİ	670 x 490 x 440	5,5 + 5,5 lt	500,00



180° AÇILIR KAPAKLI YUVARLAK REŞO / ÇORBALIK
ROUND CHAFING DISH WITH 180° ROLL TOP LID SOUP SERVER

KOD Code	MODEL Model	ISITMA TİPİ Heated Type	EBAT Size (mm)	GN KAPASİTE Capacity GN (Lt.)	FİYAT PRICE €
59006000001	ÇORBALIK	ELEKTRİKLİ	500 x 510 x 550	5,5	500,00
59006000004	ÇORBALIK	JEL / GEL	500 x 510 x 550	5,5	415,00



ANKASTRE 180° AÇILIR KAPAKLI CHAFING DISH
CHAFING DISH WITH 180° ROLL TOP LID BUILD IN

KOD Code	MODEL Model	ISITMA TİPİ Heated Type	EBAT Size (mm)	GN KAPASİTE Capacity GN (Lt.)	FİYAT PRICE €
59006000002	ANKASTRE / Built In	ELEKTRİKLİ	500 x 510 x 550	5,5	430,00



180° AÇILIR KAPAKLI YUVARLAK REŞO
ROUND CHAFING DISH WITH 180° ROLL TOP LID

KOD Code	MODEL Model	ISITMA TİPİ Heated Type	EBAT Size (mm)	GN KAPASİTE Capacity GN (Lt.)	FİYAT PRICE €
59006000008	STANDART	ELEKTRİKLİ	500 x 510 x 550	9	450,00
59006000009	STANDART	JEL / GEL	500 x 510 x 550	9	400,00



ANKASTRE 180° AÇILIR KAPAKLI YUVARLAK CHAFING DISH
CHAFING DISH WITH 180° ROLL TOP LID BUILD IN

KOD Code	MODEL Model	ISITMA TİPİ Heated Type	EBAT Size (mm)	GN KAPASİTE Capacity GN (Lt.)	FİYAT PRICE €
59006000007	ANKASTRE / Built In	ELEKTRİKLİ	500 x 510 x 550	9	400,00



DÜZ KAPAKLI PLASTİK SAPLI REŞO
CHAFING DISH STANDART LID

KOD Code	ISITMA TİPİ Heated Type	EBAT Size (mm)	GN KAPASİTE Capacity GN (lt)	KAPASİTE Ca-pacity (Lt.)	FİYAT PRICE €
5900200009	JEL / GEL	650 x 360 x 250	GN 1/1-65	9	240,00
5900200008	ELEKTRİKLİ	650 x 360 x 250	GN 1/1-65	9	320,00



ROLL TOP KAPAKLI REŞO
CHAFING DISH WITH ROLL TOP LID WITH PLASTIC HANDLE

KOD Code	ISITMA TİPİ Heated Type	EBAT Size (mm)	GN KAPASİTE Capacity GN (lt)	KAPASİTE Ca-pacity (Lt.)	FİYAT PRICE €
5900200014	JEL / GEL	650 x 350 x 450	GN 1/1-65	9	270,00
5900200013	ELEKTRİKLİ	650 x 350 x 450	GN 1/1-65	9	340,00



DÜZ KAPAKLI İSTİFLENEBİLİR EKO MODEL REŞO
CHAFING DISH STANDART LID ECONOMIC

KOD Code	ISITMA TİPİ Heated Type	EBAT Size (cm)	KAPASİTE Capacity (Lt.)	FİYAT PRICE €
5900200010	JEL / GEL	630 x 320 x 220	9	200,00



ROLL TOP KAPAKLI EKONOMİK REŞO
ECONOMIC CHAFING DISH WITH ROLL TOP LID ECONOMIC

KOD CODE	ISITMA TİPİ Heated Type	EBAT DIMENSION (mm)	GN KAPASİTE CAPACITY GN (lt)	KAPASİTE CAPACITY (Lt.)	FİYAT PRICE €
5900200015	JEL / GEL	630 x 320 x 340	GN 1/1-65	9	220,00



ÇORBALIK
BODY SOUP SERVER

KOD Code	ISITMA TİPİ Heated Type	VOLTAJ Voltahe	KAPASİTE Capacity (Lt.)	AĞIRLIK Weight (kg)	FİYAT PRICE €
99050080003	ELEKTRİKLİ	600 w	12,0	10	160,00



REŞO PARÇALARI
SPARE PARTS

KOD Code	YEDEK PARÇA SPARE PARTS	FİYAT PRICE €
10040210050	Reşo Pleyt (Termostatlı)	70,00
B0013000003	Reşo Yakıt Kabı	13,00
B0013000031	Reşo Suluk	55,00
B0013000025	Reşo Kapak (Düz - Standart)	80,00
B0013000039	Reşo Kapak Rolltop	100,00



PREMIUM ETHANOL REŞO YAKITLARI
PREMIUM ETHANOL GEL

KOD Code	YAKIT TİPİ Gel Type	KAPASİTE Capacity	FİYAT PRICE €
99040030001	Tin. Can	200 gr	1,00
99040030002	Plastic Bucket	4 kg	20,00

TENCERE KIZARTMA TELİ ÇİFT SAPLI
FRY BASKET WITH 2 HANDLES DEEP

KOD Code	EBAT Size (cm)	YÜKSEKLİK HEIGHT (cm)	FİYAT PRICE €
99020140013	30	15	26,00
99020140014	36	20	30,00
99020140015	40	17	35,00
99020140016	45	20	37,00
99020140017	50	20	39,00
99020140018	55	20	45,00
99020140019	60	20	53,00
99020140020	65	20	57,00
99020140021	70	30	66,00
99020140022	80	30	71,00

TAVA KIZARTMA TELİ ÇİFT SAPLI
FRY BASKET WITH 2 HANDLES SHALLOW

KOD Code	EBAT Size (cm)	YÜKSEKLİK HEIGHT (cm)	FİYAT PRICE €
99020130074	36	9	26,00
99020130075	40	11	27,00
99020130076	45	12	32,00
99020130077	50	12	36,00
99020130078	55	14	39,00
99020130079	60	15	44,00
99020130080	65	15	50,00
99020130081	70	15	64,00
99020130082	80	16	73,00

SÜT SÜZGEÇİ
MILK STRAINER

KOD Code	MODEL	EBAT Size (cm)	FİYAT PRICE €
99020120025	SÜT SÜZGEÇİ-1	16	4,00
99020120026	SÜT SÜZGEÇİ-2	20	5,00
99020120027	SÜT SÜZGEÇİ-3	24	6,00
99020120028	SÜT SÜZGEÇİ-4	28	7,00
99020120029	SÜT SÜZGEÇİ-0	30	8,00

TEL KEVGİR DÜZ SIK
WIRE MESH SKIMMER, DENSE

KOD CODE	MODEL	EBAT DIMENSION (cm)	FİYAT PRICE €
99020060056	TEL KEVGİR SIK-1	16	3,00
99020060057	TEL KEVGİR SIK-2	20	4,00
99020060058	TEL KEVGİR SIK-3	24	5,00
99020060059	TEL KEVGİR SIK-4	28	6,00
99020060060	TEL KEVGİR SIK-0	30	7,00

TEL KEVGİR DÜZ SEYREK
WIRE MESH SKIMMER SPARSE

KOD CODE	MODEL	EBAT DIMENSION (cm)	FİYAT PRICE €
99020060051	TEL KEVGİR SEYREK-1	16	3,00
99020060052	TEL KEVGİR SEYREK-2	20	4,00
99020060053	TEL KEVGİR SEYREK-3	24	5,00
99020060054	TEL KEVGİR SEYREK-4	28	6,00
99020060055	TEL KEVGİR SEYREK-0	30	7,00

TEL KEVGİR DERİN SEYREK
WIRE MESH SKIMMER SPARSE

KOD CODE	MODEL	EBAT DIMENSION (cm)	FİYAT PRICE €
99020060042	TEL KEVGİR SEYREK-2	22	6,00
99020060043	TEL KEVGİR SEYREK-3	24	7,00
99020060044	TEL KEVGİR SEYREK-4	27	8,00
99020060045	TEL KEVGİR SEYREK-0	30	9,00

TEL KEVGİR DERİN SIK
WIRE MESH STRAINER SPARSE

KOD CODE	MODEL	EBAT DIMENSION (cm)	FİYAT PRICE €
99020060048	TEL KEVGİR SEYREK-2	22	6,00
99020060049	TEL KEVGİR SEYREK-3	24	7,00
99020060050	TEL KEVGİR SEYREK-4	27	8,00
99020060039	TEL KEVGİR SEYREK-0	30	9,00

TEL ÇİRPİCİ / S/S WHISK

KOD Code	MODEL	UZUNLUK Length (cm)	FİYAT PRICE €
99020040029	ÇİRPİCİ İTHAL-1	30	10,00
99020040030	ÇİRPİCİ İTHAL-2	40	13,00
99020040031	ÇİRPİCİ İTHAL-3	50	15,00

ÇİRPİCİ
WHISK

KOD Code	MODEL	UZUNLUK Length (cm)	FİYAT PRICE €
99020040017	KOMPLE PASLANMAZ-1	20	9,00
99020040019	KOMPLE PASLANMAZ-2	30	10,00
99020040021	KOMPLE PASLANMAZ-3	40	11,00
99020040022	KOMPLE PASLANMAZ-4	50	12,00
99020040024	KOMPLE PASLANMAZO	60	13,00
99020040025	KOMPLE PASLANMAZ-6	70	14,00
99020040026	KOMPLE PASLANMAZ-7	80	15,00
99020040027	KOMPLE PASLANMAZ-8	90	16,00
99020040016	KOMPLE PASLANMAZ-9	100	17,00



PELİN / PELİN

KOD Code	MODEL Model	PRICE €
99110020198	YEMEK KAŞIK - DINNER SPOON	29,00
99110020122	YEMEK ÇATAL - DINNER FORK	29,00
99110020057	YEMEK BIÇAK - DINNER KNIFE	50,00
99110020185	TATLI KAŞIK - DESSERT SPOON	26,00
99110020108	TATLI ÇATAL - DESSERT FORK	26,00
99110020033	TATLI BIÇAK - DESSERT KNIFE	50,00
99110020157	NESCAFE KAŞIK - NESCAFE SPOON	25,00
99110020167	ORDOVR KAŞIK -ORDOVR SPOON	26,00
99110020095	ORDOVR ÇATAL -ORDOVR FORK	26,00
99110020021	ORDOVR BIÇAK -ORDOVR KNIFE	50,00
99110020003	BALIK BIÇAĞI - FISH KNIFE	65,00
99110020079	BALIK ÇATALI - FISH FORK	29,00
99110020135	ÇAY KAŞIĞI - TEA SPOON	24,00



PINAR / PINAR

KOD Code	MODEL Model	PRICE €
99110020202	YEMEK KAŞIK - DINNER SPOON	26,00
99110020125	YEMEK ÇATAL - DINNER FORK	26,00
99110020061	YEMEK BIÇAK - DINNER KNIFE	50,00
99110020189	TATLI KAŞIK - DESSERT SPOON	23,00
99110020112	TATLI ÇATAL - DESSERT FORK	23,00
99110020037	TATLI BIÇAK - DESSERT KNIFE	50,00
99110020159	NESCAFE KAŞIK - NESCAFE SPOON	23,00
99110020139	ÇAY KAŞIK - TEA SPOON	22,00



SARAY / SARAY

KOD Code	MODEL Model	PRICE €
99110020203	YEMEK KAŞIK - DINNER SPOON	20,00
99110020126	YEMEK ÇATAL - DINNER FORK	20,00
99110020062	YEMEK BIÇAK - DINNER KNIFE	25,00
99110020190	TATLI KAŞIK - DESSERT SPOON	16,00
99110020113	TATLI ÇATAL - DESSERT FORK	16,00
99110020041	TATLI BIÇAK - DESSERT KNIFE	22,00
99110020131	ÇAY KAŞIK - TEA SPOON	12,00
99110020155	NESCAFE KAŞIK - NESCAFE SPOON	16,00



MAKARNA MAŞASI / SPAGHETTI TONG

KOD Code	UZUNLUK Length (cm)	FİYAT PRICE €
99020070023	22	4,00



SALATA MAŞASI / SALAD TONG

KOD Code	UZUNLUK Length (cm)	FİYAT PRICE €
99020070027	22	4,00



PASTA MAŞASI / CAKE TONG

KOD Code	UZUNLUK Length (cm)	FİYAT PRICE €
99020070025	21,5	4,00



ŞEKER MAŞASI / SUGAR TONG

KOD Code	UZUNLUK Length (cm)	FİYAT PRICE €
99020070030	12	2,00



BUZ MAŞASI / ICE TONG

KOD Code	UZUNLUK Length (cm)	FİYAT PRICE €
99020070013	16	2,00



IZGARA MAŞASI / GRILL TONG

KOD Code	UZUNLUK Length (cm)	FİYAT PRICE €
99020070015	32,5	16,00
99020070022	27	13,00
99020070020	24,5	10,00

SANAYİ TİPİ KEPÇE / HEAVY DUTY LADLE



KOD Code	MODEL NO	AĞIZ GENİŞLİĞİ Edge Wideness (cm)	SAP UZUNLUK Handle Length (cm)	FİYAT PRICE €
99020060011	(NO:1)	8	33	6,00
99020060013	(NO:2)	9	36	7,00
99020060014	(NO:3)	10	42,5	8,00
99020060015	(NO:4)	11	47,5	10,00
99020060016	(NO:5)	13,5	57	11,00
99020060017	(NO:6)	15,5	62,5	20,00
99020060018	(NO:7)	18	70	30,00
99020060019	(NO:8)	20,5	80	37,00
99020060020	(NO:9)	23	90	48,00
99020060012	(NO:10)	25,5	100	56,00

SANAYİ TİPİ KEVGİR / HEAVY DUTY SKIMMER



KOD Code	MODEL NO	AĞIZ GENİŞLİĞİ Edge Wideness (cm)	SAP UZUNLUK Handle Length (cm)	FİYAT PRICE €
99020060029	(NO:1)	9	33	6,00
99020060031	(NO:2)	10,5	33	7,00
99020060032	(NO:3)	11	42,5	8,00
99020060033	(NO:4)	12,5	47,5	10,00
99020060034	(NO:5)	15	57	11,00
99020060035	(NO:6)	17,5	62,5	20,00
99020060036	(NO:7)	19	70	30,00
99020060037	(NO:8)	23	80	40,00
99020060038	(NO:9)	25,1	90	48,00
99020060030	(NO:10)	28	100	56,00

SERVİS KAŞIK / SERVING SPOON



KOD Code	MODEL	SAP UZUNLUK Handle Length (cm)	AĞIZ GENİŞLİĞİ Edge Wideness (cm)	FİYAT PRICE €
99110020174	DÜZ - SMOOTH	NO : 2	6,3	7,00
99110020173	DELİKLİ - PERFORATED	NO : 2	6,3	7,00
99110090014	SOS KEPÇE - SAUCE LADLE	NO : 3	-	6,00
99110090012	SOS KEPÇE - SAUCE LADLE	No : 4	-	7,00

SERVİS SPATULA / SERVING SPATULA

KOD Code	MODEL	SAP UZUNLUK Handle Length (cm)	AĞIZ GENİŞLİĞİ Edge Wideness (cm)	FİYAT PRICE €
99110180007	NO : 1	28,5	8	7,00
99110180008	NO : 2	41	8	7,00



THERMO TEPŞİ İZOLASYONLU
THERMO TRAY ISOLATED

KOD Code	MODEL Model	EBAT Size (mm)	FİYAT PRICE €
99110160012	6 GÖZLÜ TABAKSIZ Without Plate	540 x 380 x 100	64,00
23 cm Düz Tabak ya da 20 cm Çukur Tabak 17 cm Kare Kayık Tabak ya da 12 cm Joker Kase 14 cm Kare Kayık Tabak - Fincan - 12 cm Joker Kase 17 cm Kare Kayık Tabak ya da 12 cm Joker Kase			
Porselenler FİYATA Dahil Değildir.			



THERMO TEPŞİ TAŞIMA ARABASI
THERMO TRAY CARRYING TROLLEY

KOD Code	KAPASİTE Capacity	EBAT Size (mm)	FİYAT PRICE €
99110230014	15 ADET	620 x 800 x 108	594,00
2 ADET GN 1/4 KÜVET DAHİLDİR.			

THERMO TEPŞİLER FİYATA DAHİL DEĞİLDİR.
THERMO TRAYS ARE NOT INCLUDED TO THE PRICES



ÜRÜN ÖZELLİKLERİ

- *Bulaşık makinesinde yıkanabilir.
- *+100°C sığağa, -40°C soğuğa dayanıklıdır.
- *Ürün iç yüzeyinin kolay temizlenebilmesi ve hijyenik olabilmesi için parlak ve pürüzsüzdür.
- *Ekstra güçlendirilmiş köşe yapısına sahiptir.
- *53 lt - 63 lt arasında taşıma kapasitesine sahiptir.
- *Üst üste dizilebilir.
- *Hafif gövde yapısı sayesinde taşıma kolaylığı sağlar.
- *İnsan sağlığına zararlı madde içermemektedir.
- *Talebe göre renk seçenekleriyle üretilebilir.
- *Kapak gövdeden bağımsızdır.Yükleme kolaylığı sağlar.

PRODUCT SPECIFICATIONS

- *Dishwasher safe
- *Can withstand temperatures from -40 °C to 100°C
- *Smooth inside surface that hygienic and easy to clean
- *Features tough reinforced corners
- *Can carry from 53lt to 63lt
- *Light case that is easy to lift
- *Stackable
- *Double walls filled with polyurethane foam
- *Does not contain any substances harmful to human health

THERMOBOX

KOD Code	MODEL Model	DIŞ EBAT Ext. Dim. (cm)	İÇ EBAT Int. Dim. (mm)	KAPASİTE Capacity (Lt.)	FİYAT PRICE €
99090020002	600	62 x 43 x 66	540 x 330 x 510	90	250,00



ET KESME TAHTASI / CUTTING BOARD

KOD Code	EBAT / Size (cm)	FİYAT PRICE €
99080020015	30 x 50 x 2	18,00
99080020016	30 x 50 x 4	36,00
99080020037	50 x 70 x 4	82,00
99080020028	40 x 60 x 4	56,00
99080020025	60 x 40 x 2	28,00
99080020033	50 x 50 x 4	59,00

Özel Ölçüye göre sipariş alınır



LAMİNE SELF SERVİS TEPŞİ
LAMINATED SELF SERVING TRAY

KOD Code	MODEL	EBAT Size (cm)	KALINLIK Size (mm)	FİYAT PRICE €
99110220098	LAMİNE SELF SERVİS TEPŞİSİ	32,5 x 53	2,00	7,00
99110220150	LAMİNE SELF SERVİS TEPŞİSİ (Eco)	37 x 53	2,00	6,00
99110220100	LAMİNE SELF SERVİS TEPŞİSİ	32 x 42	2,00	5,00
99110220097	LAMİNE SELF SERVİS TEPŞİSİ	24 x 34	2,00	3,00
99110220111	LAMİNE SELF SERVİS TEPŞİSİ	Ø43,5	2,00	7,00
99110220107	LAMİNE SELF SERVİS TEPŞİSİ	43 x 61	2,00	15,00
99110220149	LAMİNE SELF SERVİS TEPŞİSİ	36 x 46	2,30	6,00
99110220147	KAYMAZ LAMİNE SERVİS TEPŞİSİ - NON-SLIP	32,5 x 53	2,30	8,00
99110220102	KAYMAZ LAMİNE SERVİS TEPŞİSİ (Eco) - NON-SLIP	37 x 53	2,30	7,00
99110220099	KAYMAZ LAMİNE SERVİS TEPŞİSİ - NON-SLIP	32 x 42	2,30	7,00
99110220096	KAYMAZ LAMİNE SERVİS TEPŞİSİ - NON-SLIP	24 x 34	2,30	18,00
99110220153	KAYMAZ LAMİNE SERVİS TEPŞİSİ - NON-SLIP	48 x 75	2,30	30,00
99110220148	KAYMAZ LAMİNE SERVİS TEPŞİSİ - NON-SLIP	36 x 46	2,30	7,00
99110220110	KAYMAZ LAMİNE SERVİS TEPŞİSİ - NON-SLIP	Ø43	2,30	13,00
99110220160	KAYMAZ LAMİNE SERVİS TEPŞİSİ - NON-SLIP	Ø38	2,30	9,00



ÇÖP ARABASI / WASTE TROLLEY

KOD Code	MODEL	EBAT Size (mm)	KAPASİTE Capacity (Lt.)	FİYAT PRICE €
40500000001001	PEDALSIZ - W.OUT PEDAL	Ø 40 x 40	49	155,00
40500000001002	PEDALSIZ - W.OUT PEDAL	Ø 45 x 45	71	185,00
40500000001003	PEDALSIZ - W.OUT PEDAL	Ø 50 x 50	96	210,00

İthal Ürünler

Import Products



www.kayalarmutfak.com.tr

444 5 957



BUZ MAKİNASI
ICE MAKER MACHINE

KOD CODE	MODEL	KAPASİTE (Kg/Gün) CAPACITY (Kg/Day)	DEPO KAPASİTESİ ICE STORAGE	EBAT Size (mm)	GÜÇ POWER W / V	FİYAT PRICE €
99050040008	FR 25	25	4	355 x 435 x 590	400 / 220	1.260,00
99050040012	FR 35	32	16	500 x 580 x 690	500 / 220	1.640,00
99050040015	FR 50	47	28	500 x 580 x 800	600 / 220	1.912,00
99050040017	FR 70	67	40	738 x 600 x 822	800 / 220	2.570,00
99050040019	FR 90	85	40	738 x 600 x 822	1100 / 380	2.955,00

- TR** * Yatay konumdaki evaporatöre, sistem üzerinden alınan filtre edilmiş suyun püskürtülmesi ile kristal görünümlü buz üretme kabiliyeti.
 * Inox 304 kalite paslanmaz gövde kalitesi ile kolay temizlenebilir yüzeyler
 * Elektronik kontrol sistemi sayesinde su ve enerji tasarrufu sağlar.
 * Yüksek buz saklama kapasitesi ile depolama sağlar.
 * Tropikal iklim sınıfı ile yaz - kış farkı yaratmadan yüksek performans ile çalışır

- EN** * Crystal looking ice production capability by spraying filtered water taken from the system to horizontal positioned evaporator.
 * Easy clean surfaces with inox 304 quality stainless steel trunk.
 * The electronic control system saving water and energy
 * It provides storage with the highest storage capacity.
 * It works with high performance without creating summer/winter difference with the tropical climate type,

TAM OTOMATİK ESPRESSO
FULL AUTOMATIC ESPRESSO MACHINE

KOD Code	MODEL Model	EBAT Size (cm)	BOYLER Boiler (Lt)	ÖĞÜTÜCÜ MOTOR Grinder Engine (kw/rpm)	GÜÇ Power (kW)	FİYAT PRICE €
99050210003	MTE -1G	50 x 52 x 42	7,5	2600	1,8	4.500
99050210001	MTE -2G	71 x 52 x 42	11,5	2600	2,6	5.700
99050210002	MTE -3G	88 x 52 x 42	18	3200	3,7	7.300

- TR** * İnfüzyon ekstraksiyon sistemi ile Mono-blok 2 kilo pirinç grup başları
 * Paslanmaz galvanizli çelik şase; Paslanmaz çelik çalışma yüzeyleri.
 * Her grup başı için bağımsız termo sifon ısı eşanjörlü bakır kazan.
 * İki adet paslanmaz çelik döner buhar çıkışı ve bir adet sıcak su çıkışı.
 * Dahili motor pompası; Elektronik olarak kontrol edilen su seviyesi.
 * Teflondan yapılmış ikinci boru.

- EN** * Mono-block 2 kilo brass group heads with infusion-extraction system.
 * Rustproof galvanised steel chassis; stainless steel working surfaces.
 * Copper boiler with independent thermo-siphon heat exchangers for each group head.
 * Two stainless steel rotational steam outlets and one hot water outlet.
 * Internal motor pump; electronically controlled water level.
 * Secondary tubing made of Teflon.

KAHVE DEĞİRMENİ
COFFEE GRINDER

KOD Code	EBAT Size (cm)	AĞIRLIK Weight (kg)	KAPASİTE Capacity (kg)	ÖĞÜTME Grinding (kg/h)	GÜÇ Power (W)	FİYAT PRICE €
99050210006	42 x 45 x 89	6	1,5	9	270	800,00

- TR** * 2 kg Hazne kapasitesi.
 * 600 gr dozlama odası.
 * 497 watt motor, 65 mm taşlama diskleri.
 * 65cm yüksek.
 * Sadece 63 db'lik gürültü seviyesi.

- EN** * 2 kg Hopper capacity.
 * 600 g dosing chamber.
 * 497 watt motor, 65 mm grinding disks.
 * 65 cm high.
 * Noise level of just 63 db.

FİLİTRE KAHVE MAKİNASI
FILTER COFFEE MACHINE

KOD Code	EBAT Size (cm)	KAPASİTE Capacity (Lt.)	GERİLİM Voltage	FİYAT PRICE €
99050210007	19 x 37 x 43	120 Cup	220 V	900,00
99110150001 (Kahve Potu)	-	1,5 Lt.	-	20,00

- TR** * Yüksek kalite paslanmaz çelik
 * Kahve hazırlık süresi 6 dk
 * Kullanımı ve temizliği kolay
 * Ergonomik tasarım
 * Kendinden regüleli ocak tabakları
 * Ayrı ayrı kullanılabilen sıcak tabaklar
 * Kuru kaynama koruması

- EN** * High quality stainless steel
 * Coffee preparation time 6 min
 * Easy to use and clean
 * Ergonomic design
 * Self-regulating cooker plates
 * Individually available hot plates
 * Dry boiling protection

KATI MEYVE PRESİ
JUICER EXTRACTOR MACHINE

KOD Code	MODEL Model	EBAT Size (mm)	AĞIRLIK Weight (kg)	GÜÇ Power (W)	FİYAT PRICE €
99050260001	J45B	200 x 240 x 430	6	700	330,00

PORTAKAL SIKMA MAKİNESİ
CITRUS JUICER

KOD Code	MODEL	EBAT Size (mm)	GÜÇ Power (W)	AĞIRLIK Weight (kg)	FİYAT PRICE €
99050340003	CJ-4	350 x 240 x 400	180	6	265,00

DİJİTAL BLENDER
DIGITAL BLENDER

KOD Code	MODEL	EBAT Size (mm)	KAPASİTE Capacity (Lt.)	GÜÇ Power (W)	AĞIRLIK Weight (kg)	FİYAT PRICE €
99050280033	BL-020	190 x 220 x 580	2	1500	5,3	560,00

BAR MİKSER
BAR MIXER

KOD Code	MODEL	EBAT Size (mm)	AĞIRLIK Weight (kg)	GÜÇ Power (W)	FİYAT PRICE €
99050280009	DN-A	260 x 210 x 580	6,5	400	325,00

KOLLU PORTAKAL SIKACAĞI
MANUEL CITRUS JUICER

KOD Code	Model	EBAT Size (mm)	AĞIRLIK Weight (kg)	FİYAT PRICE €
99050340004	KP 15	190 x 290 x 450	8	140,00

ET KIYMA MAKİNASI
MEAT MINCING MACHINE

KOD CODE	MODEL	EBATLAR DIMENSIONS (mm)	AĞIRLIK WEIGHT (kg)	KAPASİTE CAPACITY (Kg / Saat / H)	GÜÇ POWER (KW / V)	FİYAT PRICE €
99050220001	No : 22M	360x780x610	60	400	1.5 / 220	1.550,00
99050220003	No : 22T	360x780x610	60	400	1.5 / 380	1.500,00
99050220004	No : 32M	370x880x610	82	600	2.2 / 220	1.700,00
99050220006	No : 32T	370x880x610	82	600	3.0 / 380	1.650,00

- TR** - Paslanmaz çelik helezon, boğaz ve boğaz somunu.
- Kolay sökülebilir et haznesi ile kolay temizlik imkanı.
- El koruma ünitesi ile güvenli çalışma imkanı.
- Paslanmaz çelik gövde.

- EN** - Stainless steel handwheel and spiral.
- Easy removable handwheel and easy cleaning.
- Hand protection provides safe operation.
- Stainless steel body.

ET KIYMA MAKİNASI (Soğutmalı)
MEAT MINCING MACHINE (Cooled)

KOD CODE	MODEL	EBATLAR DIMENSIONS (mm)	AĞIRLIK WEIGHT (kg)	KAPASİTE CAPACITY (Kg / Saat / H)	GÜÇ POWER (KW / V)	FİYAT PRICE €
99050220002	No : 22M	360x780x610	60	400	1.5 / 220	1.870,00
99050220005	No : 32M	370x880x610	82	600	2.2 / 220	2.170,00

- TR** - Paslanmaz çelik helezon, boğaz ve boğaz somunu.
- Kolay sökülebilir et haznesi ile kolay temizlik imkanı.
- El koruma ünitesi ile güvenli çalışma imkanı.
- Paslanmaz çelik gövde.

- EN** - Stainless steel handwheel and spiral.
- Easy removable handwheel and easy cleaning.
- Hand protection provides safe operation.
- Stainless steel body.

ET KEMİK TESTERESİ
ANODIZED BONE SAW

KOD CODE	MODEL	EBATLAR DIMENSIONS (mm)	TESTERE UZUNLUĞU SAW LENGTH (mm)	GÜÇ POWER (KW / V)	FİYAT PRICE €
99050420001	KET 211T	580x650x1050	1846	1,1 / 220	1.850,00
99050420002	KET 300T	800x860x1700	2485	1.5 / 380	8.500,00

SİRAL HAMUR YOĞURMA MAKİNASI (ÇİFT DEVİRLİ)
SPIRAL DOUGH MIXERS (DOUBLE SPEED)

KOD CODE	EBATLAR DIMENSIONS (mm)	KAZAN EBATLARI BOWN DIM. (mm)	UN / HAMUR KAPASİTESİ FLOUR CAP. (Kg)	GÜÇ POWER (KW / V)	FİYAT PRICE €
99050170021	380x620x660	500 x 300	4 / 8	0,37 / 220	1.200,00
99050170019	680x1080x1110	600 x 300	20 / 40	2,2 / 380	3.000,00
99050170020	720x1110x1050	700 x 380	30 / 60	3,0 / 380	3.600,00

- TR** - 750 / 1500 D / Dk. 380 V motor gücü.
 - İki hızlı çalışabilen hamur karıştırma kolu.
 - Zaman ayarlı dijital kontrol panosu.
 - Acil stop
 - Paslanmaz çelik hamur karıştırma kolu ve kazan

- EN** - 750 / 1500 rpm 380 V
 - Two speed dough mixer arm.
 - Equipped with double circuit timer and digital control panel.
 - Emergency stop.
 - Stainless steel bowl and dough mixer arm.

PLANET HAMUR YOĞURMA MAKİNASI
PLANET DOUGH MIXERS

KOD CODE	EBATLAR DIMENSIONS (mm)	KAPASİTESİ CAPACITY. (Lt.)	GÜÇ POWER (KW / V)	FİYAT PRICE €
99050280023	680x980x1220	20	1,1-1,5 / 220	2.470,00
99050280024	680x980x1230	30	1,5-1,8 / 380	2.580,00
99050280025	680x980x1250	40	1,5-1,8 / 380	3.050,00

- TR** - 750 / 1500 D / Dk. 380 V motor gücü.
 - İki hızlı çalışabilen hamur karıştırma kolu.
 - Zaman ayarlı dijital kontrol panosu.
 - Acil stop
 - Paslanmaz çelik hamur karıştırma kolu ve kazan

- EN** - 750 / 1500 rpm 380 V
 - Two speed dough mixer arm.
 - Equipped with double circuit timer and digital control panel.
 - Emergency stop.
 - Stainless steel bowl and dough mixer arm.

HAMUR AÇMA MAKİNASI
DOUGH ROLLER

KOD Code	EBATLAR DIMENSIONS	AĞIRLIK Weight (kg)	HAMUR ÖLÇÜLERİ DOUGH DIAM. (mm)	GÜÇ POWER KW / V	FİYAT PRICE €
99050170001	440 x 540 x 660	45	30	0,37 / 220	1.260,00
99050170002	550 x 550 x 720	40	40	0,37 / 220	1.450,00

- TR** - 1400 D/DK-220V motor gücü.
 - Ayarlanabilir hamur kalınlığı.
 - Pleksiglas koruma kapağı.
 - Derlin Merdane.
 - Acil stop.
 - Paslanmaz çelik gövde.

- EN** - 1400 rpm-220V
 - Adjustable dough thickness.
 - Plexiglass protection cover.
 - Derlin Roller.
 - Emergency stop.
 - Stainless steel body.

HAMUR YOĞURMA MAKİNASI
DOUGH KNEADING MIXERS

KOD CODE	MODEL	EBATLAR DIMENSIONS (mm)	AĞIRLIK WEIGHT (Kg)	KAZAN EBATLARI BOWL DIM. (mm)	UN KAPASİTESİ FLOUR CAP. (Kg)	GÜÇ POWER (KW / V)	FİYAT PRICE €
99050170006	HYM 360M	450 x 650 x 630	46	360 x 190	10	0,37 / 220	655,00
99050170011	HYM 430M	530 x 820 x 950	75	430 x 225	20	0,55 / 220	865,00
99050170014	HYM 500M	610 x 870 x 970	98	500 x 290	30	0,55 / 220	985,00
99050170016	HYM 600M	690 x 1000 x 1050	114	600 x 300	45	1,1 / 220	1.135,00
99050170007	HYM 360T	450 x 650 x 630	46	360 x 190	10	0,37 / 380	625,00
99050170012	HYM 430T	530 x 820 x 950	75	430 x 225	20	0,55 / 380	1.135,00
99050170015	HYM 500T	610 x 870 x 970	98	500 x 290	30	0,55 / 380	925,00
99050170017	HYM 600T	690 x 1000 x 1050	114	600 x 300	45	1,1 / 380	1.075,00
99050170018	HYM 750T	930 x 1230 x 1160	158	750 x 390	75	1,5 / 380	1.340,00
99050170008	HYM 850T	1020 x 1350 x 1240	225	850 x 430	100	1,5 / 380	2.110,00
99050170013	HYM 900T	1110 x 1430 x 1250	267	750 x 390	125	2,2 / 380	2.980,00



PATATES SOYMA MAKİNASI (Zımparalı)
POTATO PEELER (Without Filter)

KOD Code	EBATLAR DIMENSIONS (mm)	KAPASİTE CAPACITY Kg/saat/h	GÜÇ POWER (KW)	FİYAT PRICE €
99050310005	480 x 770 x 920	10	0,55 / 380V	1.260,00
99050310004	480 x 770 x 920	10	0,55 / 220V	1.500,00
99050310006	480 x 790 x 1060	20	0,95 / 380V	1.450,00
99050310007	480 x 790 x 1060	25	1,50 / 380V	2.400,00

TR - Zaman ayarlı dijital kontrol panosu.
- Uzun süre kullanılabilen güçlü zımpara.
- 1-2 dk patates soyma süresi.
- Paslanmaz çelik gövde.

EN - Timer and control panel.
- Housing covered with durable abrasive.
- Peeling time: 1-2 minute.
- Stainless steel body.



SEBZE PARÇALAMA MAKİNASI
VEGETABLE CUTTER MACHINE

KOD Code	EBATLAR DIMENSIONS (mm)	AĞIRLIK WEIGHT (Kg)	KAPASİTE CAPACITY Kg	GÜÇ POWER (KW)	FİYAT PRICE €
99070060003	470 x 660 x 1000	62	8	1,5 / 220V	2.000,00



Homar Bıçağı

El ve Sebze Parçalama Bıçağı

GIDA DİLİMLEME MAKİNESİ
FOOD SLICING MACHINE



KOD Code	MODEL Model	GERİLİM Voltage (V)	BIÇAK ÇAPI Blade Diameter (mm)	KESME KALINLIĞI Cutting Size (mm)	GÜÇ Power (kW)	PRICE €
99050160007	HBS - 220	220	220	0,2 - 12	0,13	710,00
99050160008	HBS - 250	220	250	0,2 - 12	0,15	800,00
99050160009	HBS - 275	220	275	0,2 - 15	0,17	925,00
99050160010	HBS - 300	220	300	0,2 - 16	0,17	1045,00



SOĞAN DOĞRAMA MAKİNASI (Setüstü)
ONION CHOPPING MACHINE (Overtop)

KOD Code	EBATLAR DIMENSIONS (mm)	AĞIRLIK Weight (kg)	KAPASİTE CAPACITY (Kg)	GÜÇ POWER (KW / V)	FİYAT PRICE €
99050300004	310x550x340	16	7	0,37 / 220	200,00
99050300005	310x590x410	21	11	0,37 / 220	630,00



SEBZE DOĞRAMA MAKİNESİ SET ÜSTÜ / AYAKLI
VEGETABLE CUTTER MACHINE COUNTERTOP & LEGS

KOD Code	MODEL Model	KAPASİTE Capacity (kg/h)	MOTOR GÜCÜ Input Power (kW)	AĞIRLIK Weight (kg)	EBAT Size (cm)	HIZ (d/dak) Speed (rpm)	FİYAT PRICE €
99050350005	HLC - 300 Setüstü Countertop	300	0,55	25	56 x 29 x 57	260	975,00
99050350004	HLCA - 300 Ayaklı With legs	300	0,55	44	38 x 70 x 94	260	1.150,00

HLC-300 modelimizde 5 DISC FİYATA DAHİLDİR. Bütün diskler mevcuttur. BIÇAK FİYATLARI : 150 € 'dur.
HLC-300 model 5 DISC INCLUDED IN PRICE. All discs are available. KNIFE PRICES: 150 €.

DİLİMLEME



4mm

2mm

RENDELEME



7mm

4mm

3mm

OPSİYONEL BIÇAKLAR

OPTIONAL KNIVES



ÖN DİSK
H10
H8

JÜLYEN
HU2.5
HU4
HU10

PARMAN
PATATES
T10
T8

D20
D12

KÜP
PATATES
D10
D8



ÇİPS PATATES
PB4

ÇİPS PATATES
PB2

PARMAN PATATES
ÖN DİSK
E1 / E5 / E2

KÜP PATATES
ÖN DİSK
H-14



AYRAN / ŞERBET MAKİNASI
COMPACT JUICER

KOD CODE	MODEL	EBATLAR DIMENSIONS mm	KAPASİTE CAPACITY Lt.	GÜÇ POWER Kw / V	FİYAT PRICE €
99050400003	MONO	185 x 520 x 700	20	3,66 / 220	850,00
99050400004	TWIN	365 x 520 x 700	20 x 2	5,60 / 220	1.200,00
99050400005	TRIPLE	545 x 520 x 700	20 x 3	7,10 / 220	1.750,00



AYRAN / ŞERBET MAKİNASI OVAL
COMPACT JUICER ROUND

KOD CODE	MODEL	EBATLAR DIMENSIONS mm	KAPASİTE CAPACITY Lt.	GÜÇ POWER Kw / V	FİYAT PRICE €
99050400006	MONO	250 x 390 x 700	10	1,8 / 220	860,00
99050400007	TWIN	500 x 390 x 700	10 x 2	3,8 / 220	1.300,00



OTOMATİK PORTAKAL SIKMA MAKİNESİ
AUTOMATIC ORANGE JUICER MACHINE

KOD Code	MODEL Model	KAPASİTE Capacity (adet/dk)	EBAT Size (mm)	GÜÇ Power (W)	AĞIRLIK Weight (kg)	FİYAT PRICE €
99050340008	OP 20	22-25	420 x 450 x 890	120	40	2.500,00



WAFFLE MAKİNASI ÇİÇEK MODEL
WAFFLE MACHINE FLOWER TYPE

KOD Code	MODEL Model	EBAT Size (cm)	AĞIRLIK Weight (kg)	GÜÇ Power (kW)	DÖKÜM DERİNLİK Plate Depth (mm)	FİYAT PRICE €
99050440006	WB-25E	300 x 320 x 300	9	1,15	Ø25	580,00



KREP MAKİNASI
CREPE MACHINE

KOD Code	EBAT Size (mm)	AĞIRLIK Weight (kg)	GÜÇ Power (kW)	DÖKÜM DERİNLİK Plate Depth (mm)	FİYAT PRICE €
99050230001	450 x 500 x 220	21	3	Ø 40	610,00
99050230002	900 x 500 x 220	39	3 + 3	Ø40 x 2	1.100,00



MİKRODALGA FIRIN / IZGARA
MICROWAVE OVEN / GRILL

Kod Code	Model	Hacim Volume	EBAT Size (Cm)	GERİLİM Voltage (V/hz)	GÜÇ Power (W)	IZGARA GÜCÜ Grill Power (W)	FİYAT PRICE €
99050150025	G6	30 Lt	54x44,6x30	240/50Hz	1400	1100	380,00



VAKUM MAKİNASI (Çift Çeneli)
VACUUM PACKING MACHINE

KOD Code	Model	Gerilim Voltage (v)	Ebatlar Size (cm)	Vakum Yapıştırma uzunluğu Vacuum Bond length (mm)	GÜÇ Power (W)	Ağırlık Weight (Kg)	FİYAT PRICE €
99050290011	DZ-400ZF	240 V 50Hz.	44 x 42 x 75	400	900	66	1.800



ERRCO & NERO EL MİKSERİ
ERRCO & NERO HAND MIXER

KOD Code	MODEL	GERİLİM Energy (V)	MOTOR GÜCÜ Input Power (kW)	AĞIRLIK Weight (kg)	EBAT Size (mm)	FİYAT PRICE €
99050280015	MX-25	220	0,5	3	Ø155 x 790	440,00
99050280016	MX-40	220	0,44	3	Ø135 x 600	750,00
99050280013	HM-280	220	0,00	6	Ø155 x 790	360,00

HM280 ve MX25 MODELİMİZE, TEK PARÇALAYICI APARATI DAHİLDİR.
MX40 MODELİMİZE, PARÇALAYICI VE KARIŞTIRICI APARATLARI DAHİLDİR.



EKMEK DİLİMLEME MAKİNASI
BREAD SLICER MACHINE

KOD Code	EBATLAR DIMENSION (mm)	AĞIRLIK Weight (kg)	KAPASİTE CAPACITY Ekmek Bread (Saat / h)	FİYAT PRICE €
99050120002	830 x 950 x 1180	160	500	2.200,00
99050120003	950 x 950 x 1180	175	500	2.350,00



FIELD
KITCHENS





Kayalar field kitchen are designed and produced for providing hot meal to soldiers. It's a catering system designed for mobile applications with the armed force, civil defence and disaster control organizations. The oven, pots and pans which are in the mobile kitchen unit are designed as they can be taken of their places and they can be also used in stable facilities. Each cooking unit operates independently different meals can be prepared at the same time.



Transportation Options

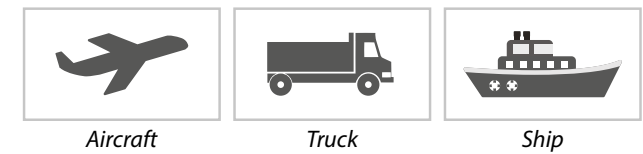

Color Options

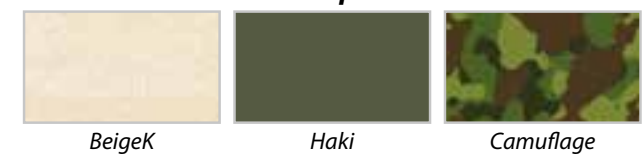

All colours available after gives Ral code.

KYL-01
600 Person

- 1- Axle and Puller Barb
- 2- Base Frame
- 3- Vehicle Side Cabinet
- 4- Upper Protection and Tent
- 5- Gas and Fire Extinguishing System
- 6- Electric and water system
- 7- Oven
- 8- Frying Pan
- 9- Burning System (Diesel, Gas or Kerosene)
- 10- Water Boiler

Cooking Equipments

Pressure Boiling Pan 180 Lt : 2 Pcs
Frying Pan 80 Lt : 2 pcs
Oven (3 x 2/1 Gn 70 Lt : 2 Pcs
Hot Water Unit 35 Lt : 2 Pcs

Burners

Multi Burner : 2 Pcs
Solid Fuel Burner : 2 Pcs

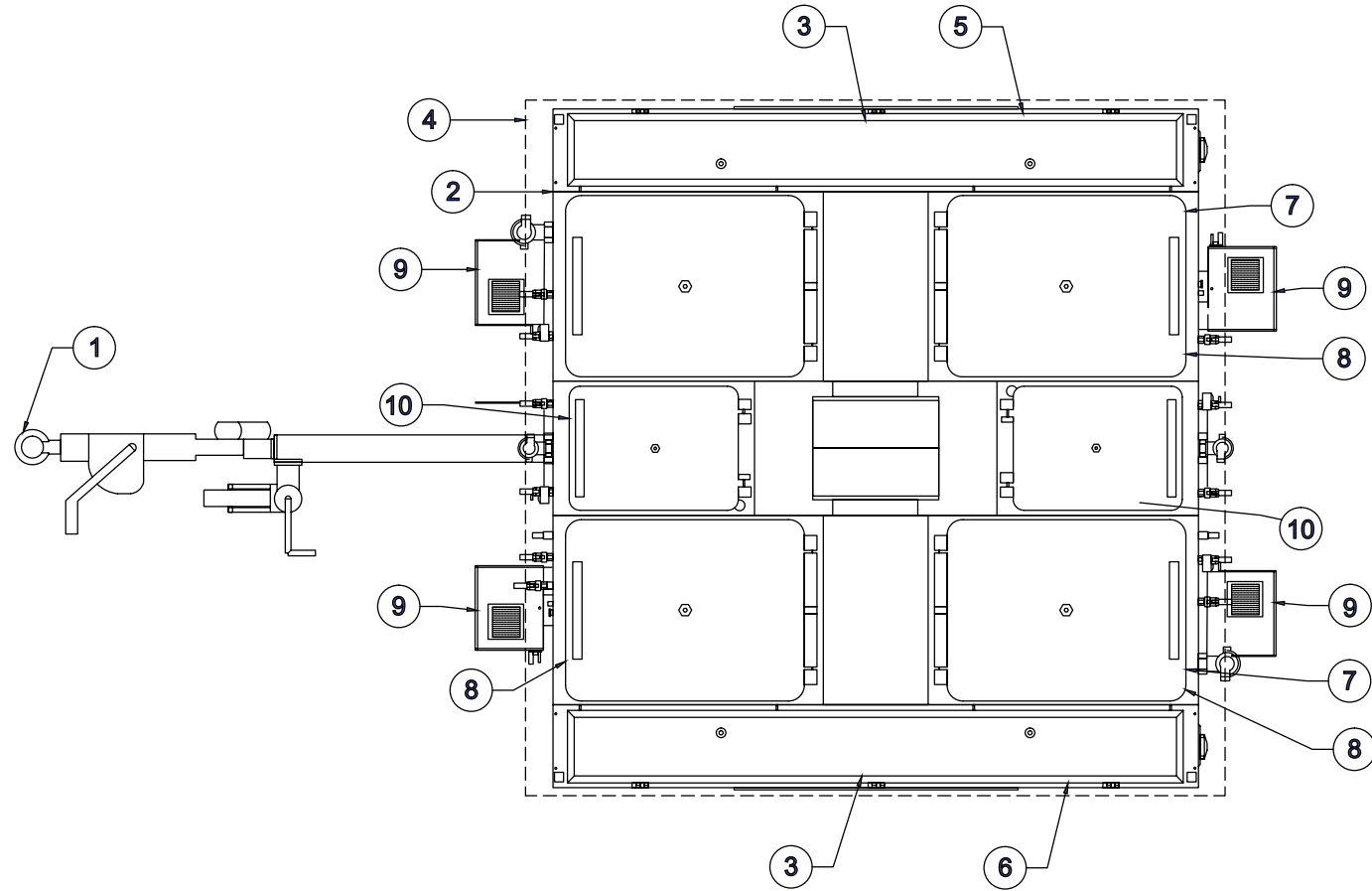

Cooking Methods

Pressure Boiling Pan : Stewing, Pressure Cooker, Boiling, Steaming

Frying Pan : Stewing, Grilling, Frying, Roasting, Boiling

Fryer : Stewing, Grilling, Frying, Boiling, Steaming

Oven : Stewing, Baking

Hot Water Unit : Boiling

Couscous Cooker (Steam Cooker) : Stewing, Pressure Cooker, Steaming



Model No : KYL-01
Net Weight : approx. 1950 Kg.
Overall Length : 3730 mm
Overall Width : 2235 mm
Overall Height : approx. 2600 mm
Height of work surfa, empty : 1050 mm
Height of work surfa, loaded : 1000 mm
Length of work surface : 1900 mm
Ground Clearance : 300 mm

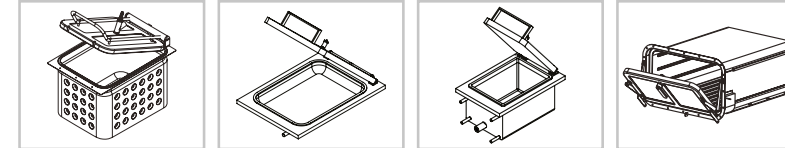

Cooking Unit	Meal Speciality	Cooking Time	Cooking Capacity	Portion Size
Frying Pan	Fried Vegetable	30 Min.	100 Person	70 - 80 gr.
	Fried Meat	30-60 Min.	100 Person	200 gr.
	Fried Chicken	30 Min	100 Person	200 - 250 gr.
Boiling Pan	Soup	60 Min.	600 Person	200 - 250 gr.
	Rice	45 Min.	600 Person	300 gr.
	Hotplate	It depends on the speciality of the food		
Oven	Meat	120 Min.	100 Person	200 gr.
	Chicken	120 Min.	100 Person	200 gr.
	Vegetable	120 Min.	100 Person	200 gr.
	Bread	120 Min.	100 Person	150 gr.
Hot Water	Tea	60 Min.	100 Person	1 Cup
	Water	60 Min.	100 Person	1 Cup

AXLE

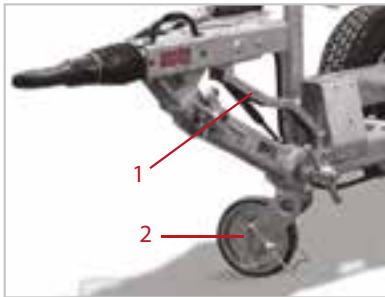

1- Hand Brake
2 - Jockey Wheel



3 - Jockey wheel adjustment arm

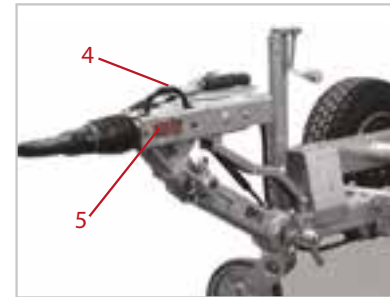

4 - Electrical Connection Socket
5 - Safety break arm

Field kitchen is mounted on a single axle trailer. The rubber torsion axle supported with two shock absorbers provides a comfortable drive. Field kitchen can be towed with any military or civil vehicle easily by the height adjustable coupling ring. The drawbar of the Field kitchen is equipped with a hand brake damper having 3 000 kg's load capacity. If the kitchen and the towing vehicle gets disconnected by accident, trailer brakes will be activated by the cable of safety break, safety transportation is ensured by automatic break system.

Generator



Engine Type : 4 Stroke Diesel
Cooling System : Air Cooled
Oil Storage Capacity : 1.75 Lt.
Alternator Type : Monophase
Continuous Voltage : 230V
Continuous Freq : 50 Hz.
Continuous Current : 30.4 Amp.
Output : 7 kWA
Max Output : 7,5 kWA
Fuel Consumption : 2.32 - 2.41/h
Size : 865 x 598 x 650mm
Total Weight : 120 - 145 Kg.
Fuel Tank Capacity : 16 Lt.

Field Kitchens with liquid fuel constantly need pressurized air. In order to meet the pressurized air requirement. A generator is supplied with mobile kitchen

Air Compressor

Field Kitchen with liquid fuel constantly need pressurized air. In order to meet the need pressurized air requirement, a compressor is supplied with mobile kitchen.



Model : KYLR-1100
Liter : 125
Bar : 8
Lt. / Min : 327
l / Min : 800
kW / Hp : 1.5 / 2.0
Size : 1350 x 420 x 850mm.
Total Weight : 110 Kg.

Awnings

All mobile kitchens are supplied with instant weather protection tent. Weather protection tent is easy to operate. The swing-up tent gives you ability to cook under waterproof and in more hygienic environment. It also gives protection from rain sun and snow.





Buharlı Kaynatma Kazanı / Boiling Pan with Steam

KOD Code	KAPASİTE Capacity (lt)	EBAT / Size (mm)	Fiyat Price €
99050330005	300		
99050330006	400	Ø 900	FİYAT ALINIZ
99050330007	500	Ø 1100	FİYAT ALINIZ

- TR**
- * Paslanmaz çelik sacdan mamul
 - * İç kazan 304 2,5 mm pres baskı formulu
 - * Dış cidar 304 kalite 2,5 mm
 - * Kapak çift cidarlı dışı 304 kalite 1,00 mm ve içi 1,20 mm sacdan pres baskılı özel formulu imal edilip argon kaynak ile kaynatılıp kaynak izleri taşlanmıştır.
 - * Kapak üzerinde yay mekanizması bulunur.
 - * Kapak contalı olup ,pişirme esnasında kilitlemesi için üzerinde 2 adet kilit mekanizması bulunur.
 - * Kapak üzerinde buhar atma ventili bulunur (kapak emniyet valfi)
 - * Kazan üzerinde cidar buhar basınç ventili ve buhar basıncını gösteren manometre bulunur.
 - * Kazan etrafı izolasyon malzemesi (cam yünü) kaplanmış olup, ısı kaybı önlenmiştir.
 - * Kazan etrafı 0,80 mm paslanmaz çelik sac ile kaplanmıştır.
 - * Kazan tabanında profil şase olup, bu şasede 4 adet yüksekliği ayarlanabilir çap 60 mm paslanmaz çelik ayak bulunmaktadır.
 - * Kazan buhar girişi 1,5" dir.
 - * Kazan buhar çıkışı ¾" dir.
 - * Kazan yemek boşaltma vanası 2" kapasiteli olup istem dışı açılmaları karşı emniyet kolludur.
 - * Kazan üst tablasında kazan içine su doldurulması için sıcak-soğuk çift su bağlantılı kuğu tip evye bataryası mevcuttur.
 - * Buharlı kazan cidar basıncı 0,4 bar/40 paskal (max. 0,5 bar) dir.
 - * Buhar tüketimi maksimum 90 kg/h
 - * Kazan gövdesi silindirik formulu olup 400 lt kapasitelidir.

- EN**
- * Made of stainless steel sheet
 - * Internal boiler 304 2,5 mm press form
 - * Outer wall 304 quality 2,5 mm
 - * Cover is double-walled outer 304 quality 1,00 mm and 1.20 mm inner plate is produced with press-printed special form, welded with argon welding and welded with welding marks.
 - * There is a spring mechanism on the cover.
 - * Cover is sealed and there are 2 locking mechanisms on it for locking during cooking.
 - * Steam vent valve on the cover (valve safety valve)
 - * There is a pressure gauge on the boiler and a manometer showing the vapor pressure.
 - * The boiler is covered with insulating material (glass wool) and heat loss is prevented.
 - * The boiler is covered with 0,80 mm stainless steel sheet.
 - * The bottom of the boiler is a profiled chassis, in which there are 4 height adjustable diameter 60 mm stainless steel feet.
 - * Boiler steam inlet is 1.5 "
 - * Boiler steam output is ¾ "
 - * The boiler food drain valve is 2 "capacity and the safety lid against unintentional opening.
 - * There is a hot-cold double water connection swan type battery for filling water into the boiler on the boiler top plate.
 - * The steam boiler has a pressure of 0,4 bar / 40 pascals (max 0.5 bar).
 - * Steam consumption maximum 90 kg / h
 - * Boiler cylinder is cylindrical form and has 400 lt capacity.



CONTAINER KITCHEN

KONTEYNER MUTFAK



www.kayalarmutfak.com.tr

info@kayalarmutfak.com.tr

444 5 957
+90 212 859 00 07

DİĞER PROJELERİMİZ

- ENDÜSTRİYEL MUTFAK PROJELERİ
- MOBİL FIRINLAR
- SAHRA MUTFAKLAR
- KIZILAY MEVLANA EVLERİ
- MOBİL EVLER

